

# VAPURE

SALT AND MINERAL CHLORINATOR

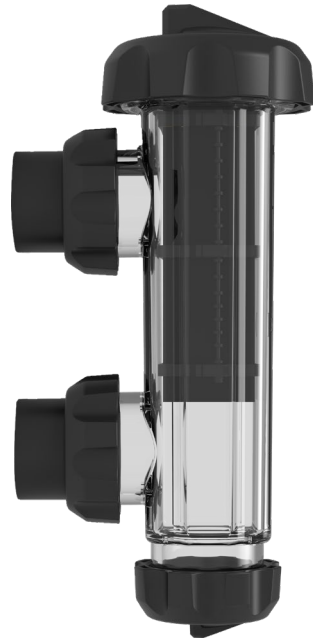

INSTALLATION & OPERATING INSTRUCTIONS

# TABLE OF CONTENTS

1.	IMPORTANT WARNINGS AND SAFETY INSTRUCTIONS .....	4
1.1	Important Warnings.....	4
1.2	Important Safety Instructions .....	4
1.3	General Warnings .....	4
2.	GENERAL OVERVIEW .....	5
2.1	Recommendations and Helpful Hints .....	6
2.2	Contents .....	6
2.3	Tools Needed .....	6
3.	POOL PREPARATION.....	7
4.	POWER PACK AND CELL INSTALLATION .....	8
4.1	Power Pack Installation .....	8
4.2	Cell Electrode Installation.....	8
4.3	Installation Diagram.....	9
4.4	CORRECT Cell Installation Methods .....	10
4.5	INCORRECT Cell Installation Methods .....	11
5.	INITIAL START-UP OF YOUR UNIT.....	12
5.1	Initial Start-up.....	12
5.2	Start-up Clock Set .....	12
5.3	Start-up Run Period.....	12
5.4	Start-up Information .....	12
5.5	Mineral or Salt Mix .....	13
5.6	Default Display Screen .....	13
6.	CONTROL PANEL OPERATION.....	14
6.1	OK BUTTON.....	15
6.2	POWER/MODE.....	15
6.3	CHLOR BOOST.....	15
6.4	WINTER/BLANKET MODE .....	16
6.5	CLOCK/TIMER.....	16
6.51	Clock Settings.....	16
6.52	Timer Settings.....	17
6.6	SALT TEST.....	18
6.7	BACKWASH .....	18
7.	UNIT MENU GUIDE .....	20
7.1	Backwash .....	20
7.2	Brightness .....	20
7.3	Cell Cleaning.....	20
7.4	Chlor Boost .....	20
7.5	Chlor Setting.....	20
7.6	Clock/Timer.....	20
7.7	Contrast .....	21
7.8	Power/Mode.....	21
7.9	Pump Setting .....	21
7.10	Salt Test.....	21

# TABLE OF CONTENTS

7.11	Service Menu.....	21
7.12	Spa Mode.....	23
7.13	Winter/Blanket Mode.....	23
7.14	pH Control Mode .....	23
8.	WATER CHEMISTRY.....	25
9.	CHLORINATOR MAINTENANCE.....	27
9.1	Inspecting and cleaning the cell Electrode.....	27
9.2	Inspecting and cleaning the Power Pack.....	28
10.	SYSTEM TROUBLESHOOTING.....	29
11.	WARRANTY.....	32
12.	TECHNICAL SUPPORT.....	34
13.	NOTES.....	35

# 1. IMPORTANT WARNINGS & SAFETY INSTRUCTIONS

## 1.1 Important Warnings



This manual contains important information about the installation, operation, and safe use of this product. This information should be given to the owner and/or operator of this equipment. When installing and using this electrical equipment, basic safety precautions should always be followed. Failure to follow safety warnings and instructions in this manual can result in serious injury and/or damage to your equipment. Read and follow all warning notices and instructions which are included in this manual.

The Power Supply internally contains live components. There is a danger of electric shock if opened. If the power cord is damaged then it should be replaced by the manufacturer, their agent or similar.

## 1.2 Important Safety Instructions



To reduce the risk of injury, do not permit young children to use this product unless they have been trained by the person responsible for their safety and they acknowledge their ability to use such equipment. To reduce the risk of accidents or incidents, service on the unit should only be performed by your local pool Professional.

## 1.3 General Warnings



When mixing acid with water, **ALWAYS ADD ACID TO WATER. NEVER ADD WATER TO ACID.**



**DO NOT PLUG UNIT IN IF THE CARTON HAS BEEN WET.**



**GAS BUILDUP CAN OCCUR WITH IMPROPER WIRING:** To reduce the risk of personal injury the Power Pack is designed so that the Electrolytic Cell will only receive power when the pool pump is on. Otherwise, dangerous chlorine gas build-up can occur. If the pump is not installed to the AC Socket (pump outlet) on the Power Pack, then the installer must ensure that the Electrolytic Cell is never energized when the pool pump is OFF, or water is not flowing through the unit.

## 2. GENERAL OVERVIEW



**Congratulations on your recent purchase of your VAPURE™ VP-Series Salt Chlorinator. Please take a moment to read through the entire manual before installing your new unit. Your chlorinator must be installed and operated as specified.**

While every effort has been made to ensure that the information contained in this guide is accurate and complete, no liability can be accepted for any errors or omissions. Crystal Aquatic Systems reserves the right to change the specifications of the hardware and software described herein at any time without prior notice.

Please remember that your VAPURE™ VP-Series Salt Chlorinator is not designed to chemically maintain your pool water and keep it balanced, but rather to produce chlorine from a mild salt solution within the water. We encourage regular water testing, balancing and correction if, and when required to maintain the recommended balanced levels of your pool water. This is a vital part of a complete maintenance program and will ensure trouble-free performance as well as a healthy and sparkling clean pool.

There is one design, comprising 8 different models in our range:

The models available (VP15, 15LS, 25, 25LS, 35, 35LS, 45 and 55) are all reverse polarity units designed to automatically change direction every 4-16hrs (depending on your setting). **See 7.3 CELL CLEANING** to change the reversing times. This change of polarity causes the calcium to dislodge and keep the cell plates clean. Please note occasional cleaning of the electrode plates may still be necessary.

**Thank you again for choosing a VAPURE™ VP-Series Salt Chlorinator. We wish you many happy years swimming in your crystal-clear pool.**



# 2. GENERAL OVERVIEW

## 2.1 Recommendations and Helpful Hints

- Read and keep your manual in a safe place.
- Increase chlorine production when temperature goes up.
- Use Stabiliser to stabilise chlorine in the swimming pool.
- Maintain your salt levels between 3500-4000 ppm (3500 ppm ideal) and at 1500-1800 ppm (1500 ppm ideal) for VP25LS and VP35LS Freshwater/Ultra-Low Salt models for optimum performance.
- Decrease production when temperature goes down - see **6.4 WINTER/BLANKET MODE**.

## 2.2 Contents

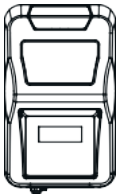

Power Pack

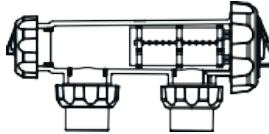

Cell Housing  
With Unions

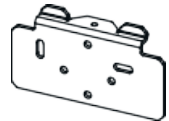

Wall Mounting  
Bracket with level

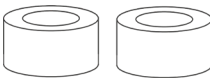

2 x 50/40  
Reducing Bushes

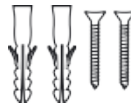

2 x Green Wall  
Plugs with Screws



The Installation &  
Operating Manual

## 2.3 Tools Needed



Drill with 6mm Bit

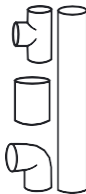

Basic PVC Fittings

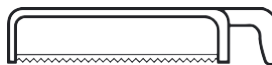

Hacksaw

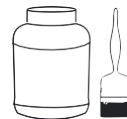

PVC Primer  
And Glue



PH2 Philips Head  
Screwdriver

# 3. POOL PREPARATION

Before operating your **VAPURE VP- Series Salt Chlorinator** please read the following:

Check your salt levels in your pool before starting your unit. **See 6.6 to perform a SALT TEST.**



Salt levels and mineral levels should ideally be 3500-4000 ppm (3500 ppm ideal) and 1500ppm – 1800 ppm (1500 ppm ideal) for VP25LS and VP35LS Freshwater/Ultra-Low Salt models. No more than 4500 ppm for regular models and 2500 ppm for Low Salt models. To achieve this TDS with minerals, you may need to add 20-30% more product to the pool water. Contact your local pool Professional for further assistance.

Salt levels above 5000 ppm (2500 ppm on Low Salt models) may overload the unit and cause excessive heat and void your warranty.

For all new pool installations please seek advice from your pool builder or your local pool Professional before adding salt, as some new surfaces request no salt to be added when initially completed.

NEVER ADD SALT/MINERALS DIRECTLY TO THE SKIMMER BOX. This high concentration of either salt or minerals will pass through your filtration, pump and other pool.

## Handy Tips



The colder the water the lower your output but this does not mean you need more salt. There will always be less chlorine demand in colder water.

We recommend adding 3.5kg of pool salt per 1000 litres of pool water, a 50,000lt new pool needs approximately 175kg of salt. For the FRESHWATER/ULTRA-LOW SALT SYSTEM Models: VP25LS and VP35LS, we recommend 1.5kg per 1000 litres of pool water.

The unit can operate on mineral/magnesium chloride salts, and you should allow an extra 20-30% of the product to achieve the correct TDS for these types of salts.

Salt should always be added to the shallow end of the pool and allowed to dissolve. Do not let the salt settle on the floor of the pool as it may cause damage to the surface. Use your pool brush to mix the salt into the water.

Running the pump will mix the water and help the salt to dissolve.

Only run the pump in the first 8-12 hours (ensure the cell is switched off) to allow the salt to dissolve.

By pressing [SALT TEST] a salt measurement is taken, and a total TDS reading is displayed. The ideal TDS reading should be an LCD display of "OK", approximately 3500-4000 ppm. If "HIGH" is displayed, the salt level is above 4500 ppm and the salt level is too high, and if "LOW" is displayed the salt is below 1000 ppm and we suggest taking a sample to your local pool Professional for a more accurate result and further assistance. For the FRESHWATER/ULTRA LOW SALT SYSTEM Models: VP25LS and VP35LS, the TDS reading is 1500-1800 ppm.

# 4. POWER PACK AND CELL INSTALLATION

## 4.1 Power Pack Installation



The VAPURE VP-Series Salt Chlorinator has an Ingress Protection Rating of IP23 enabling it to be installed outdoors. Regulations require that the Power Pack must be installed outside the pool zone. The Power Pack shall be installed according to AS/NZS 3000 wiring rules.

The Power Pack should be installed in a well-ventilated position ideally away from sunlight and rain to prolong life and at least 1m above ground to prevent run-off water entry.

Ensure that the Power Pack is not stored near chemicals, fertilisers or in a closed unventilated shed with similar products as the fumes will cause excessive corrosion and damage to the internals of the Power Pack and may void the warranty.



When mounting the Power Pack on a post it is recommended to install a flat panel at least the same size to act as a waterproof backing plate.

Mount the Power Pack with the Mounting Bracket, Green Plugs and Screws provided.

The Power Pack should be mounted no further than 1.5 metres from the Chlorinator Cell for ease of operation.

## 4.2 Cell Electrode Installation



Connect the Cell Housing horizontally in the return line to the pool (use reducing bushes supplied if 40mm PVC pipe) using high pressure PVC glue as per the figure below. The Cell Housing can be mounted vertically but provision must be made for a gas trap (See page 9).

The direction of water flow through the Cell Housing is not critical although we do recommend entry from the closed end of the Cell Housing and exit from the end closest to the Cell Locking Ring. The reason is to cause less water hammer over time on the cell plates.

Check that the O-ring is clean, greased with silicone grease (**DO NOT** use petroleum-based jelly) and securely located in the Cell Housing.

Ensure Cell Locking Ring is firmly tightened by hand (**DO NOT** use a tool to tighten).

Connect the lead from the Cell Electrode to the Cell Plug under the Power Pack ensuring a firm snap lock connection.

Plug the Power Pack 3 pin plug into a suitable weatherproof RCD protected 10amp outlet and then plug the pump into the 3 pin AC Socket located at the bottom of the Power Pack.



# 4. POWER PACK AND CELL INSTALLATION

## 4.3 Installation Diagram

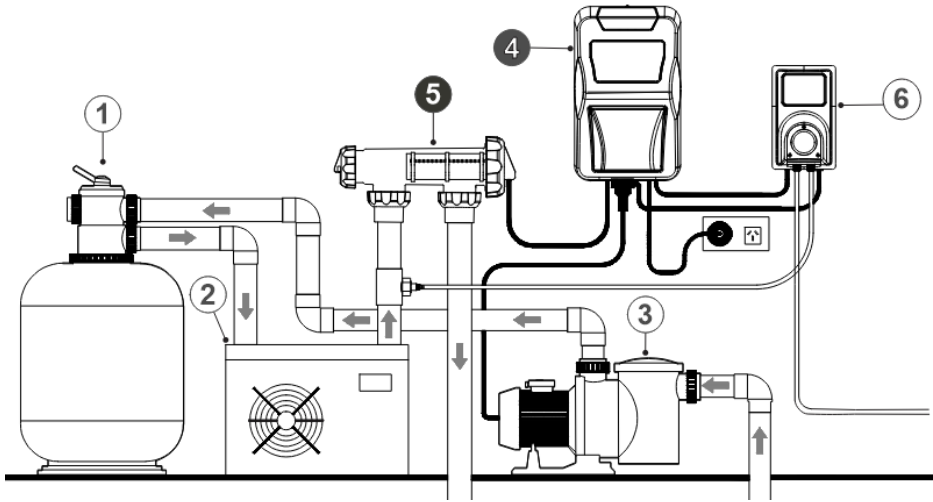

1 ● Pool Filter

2 ● Heat Pump

3 ● Pool Pump

4 ● Vapure VP Series Salt Chlorinator

5 ● Vapure VP Series Cell Housing

6 ● pH Controller



Important Notes:

**The pump rating must not exceed 8amps.**

**Saltwater may damage electrical components in the Power Pack.**

**WARNING:**

We **DO NOT** recommend the use of valves on the inlet or outlet of the cell housing. If you do use a valve, then it is important to ensure that the valve cannot deadhead (lock closed) while the pump is running. It is the installer's responsibility to ensure some form of flow control is installed in this instance and it disables the pump.

**ALWAYS** ensure that pipe work and equipment do not allow gases generated from the cell to collect and build up in any part of the installation.

It is **RECOMMENDED** that the Cell Housing be installed horizontally to create a natural gas trap that acts as a safety device. Installation in any other way may cause explosion, injury, or death if the installer does not allow for gas removal.

The Cell Housing must be installed in the **RETURN** pipework to the pool. It must always be installed after the filter, gas heater, solar heating, or heat pump.

**DO NOT** apply priming fluid to the cell Housing, it is not needed and may react with the plastic.

The cell housing has a built-in venturi pipe located in the return outlet closest to the cell cap. This assists with chlorine gas removal when the cell is installed vertically in the correct way. It will only work when installed vertically and water flows from the lower side through the inside of the cell housing and outwards through the return outlet.

## 4.4 CORRECT Cell Installation Methods

Any of these methods can allow for a natural gas trap and allow the water sensor on the cell cap to work.

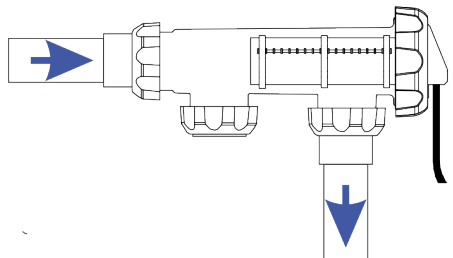
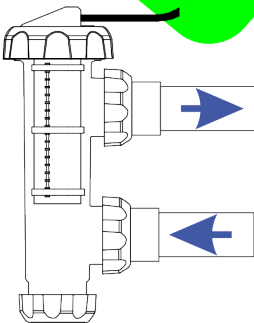
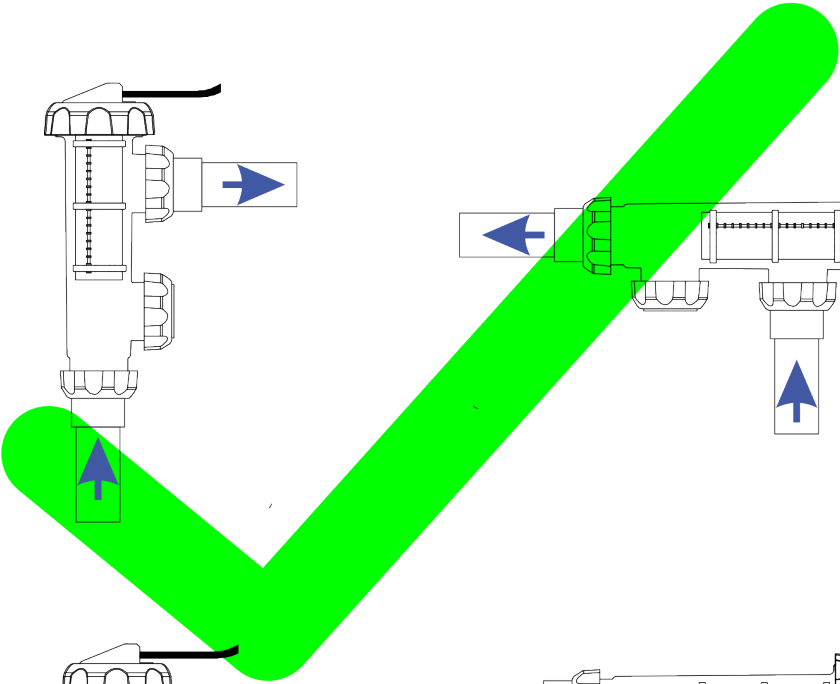
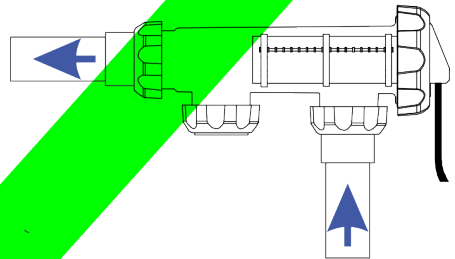
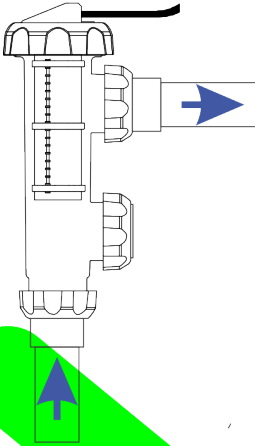
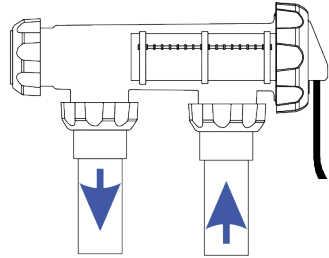
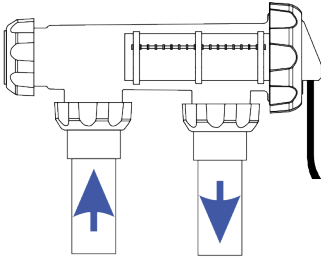

## 4.5 INCORRECT Cell Installation Methods



These two installs to the right could work if the water flow keeps the housing filled at all times. This is highly unlikely with low speed energy efficient pumps.

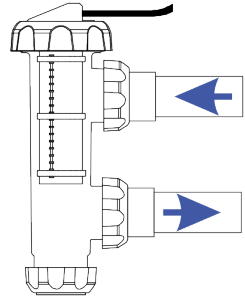
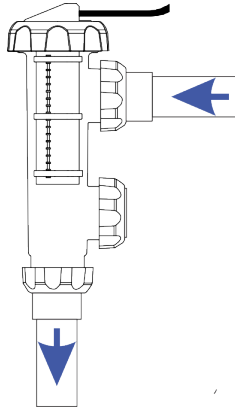

**NONE OF THESE INSTALLS BELOW WILL WORK:**

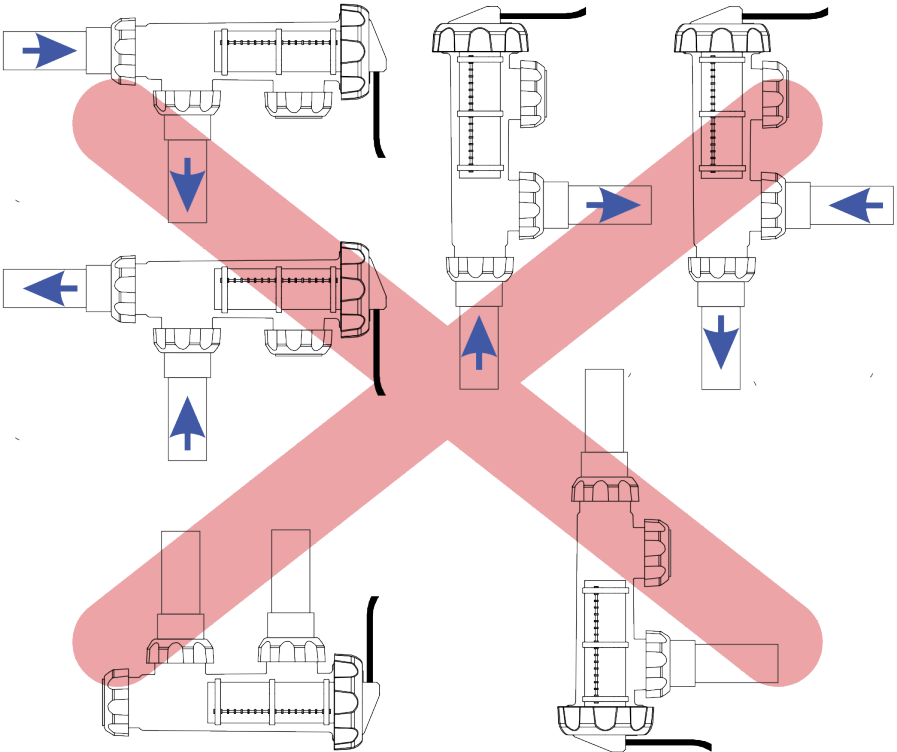

**NEVER UPSIDE DOWN LIKE THESE TWO ABOVE (no matter the flow)**

# 5. INITIAL START UP OF YOUR UNIT

## 5.1 Initial Start Up

On the initial startup of your VAPURE VP-Series Salt Chlorinator the screen to the right will be displayed.

```
EMBEDDED SOFTWARE  
< VER: SCXX.XX >  
CHECKING SYSTEM  
MODEL: 25g/hr
```

## 5.2 Start Up Clock Set

START UP CLOCK SET allows you to program the exact time of the day. HH digits will flash and pressing [+] will increase the time and pressing [-] will decrease the time.

Pressing [OK] saves the selected hour HH and MM. Pressing [<] skips this menu however you will need to set this later.

MM digits will flash and pressing [+] will increase the time and pressing [-] will decrease the time.

Pressing [OK] saves the selected hour HH and MM. Pressing [<] returns you to the previous menu screen.

```
START UP CLOCK SET  
ACTUAL TIME: HH:MM  
[+] or [-] to change  
[OK] SAVE
```

```
START UP CLOCK SET  
ACTUAL TIME: HH:MM  
[+] or [-] to change  
[OK] SAVE [<] RETURN
```

## 5.3 Start Up Run Period

START UP RUN PERIOD allows you to program your daily run times. 2 CYCLES/DAY will flash and pressing [+] or [-] will change the selection. PERIODS of running.

- 1: 2 CYCLES/DAY - unit runs from 6am-10am and 4pm-8pm
- 2: 1 CYCLE AM - unit runs from 8am - 4pm
- 3: 1 CYCLE PM - unit runs from 8pm-4am

Pressing [OK] saves the selected PERIOD. Pressing [<] returns you to the previous menu screen.

```
START UP RUN PERIODS  
PERIOD: 2 CYCLES/DAY  
[+] OR [-] TO CHANGE  
[OK] SAVE [<] RETURN
```

## 5.4 Start Up Information

START UP INFORMATION allows you to customise the unit to your pool size.

Pressing [+] or [-] will change it in 1,000ft increments. Holding the [+] or [-] in will change pool size in 5,000ft increments.

A reading of 40,000ft or similar flashes to show volume can be changed.

Pressing [OK] confirms your selection. If you do not know your pool size, you can press [OK] and set this later or contact your local pool Professional for further assistance.

Pressing [<] returns you to the previous menu screen.

```
START UP INFORMATION  
POOL SIZE: 40,000ft  
[+] or [-] to change  
[OK] SAVE [<] RETURN
```

# 5. INITIAL START UP OF YOUR UNIT

## 5.5 Salt or Mineral Mix

MINERAL OR SALT MIX allows you to enter the type of mineral used in the pool.

Pressing [+] or [-] will change it from SALT to MINERAL MIX.

The reason for this is because often a greater quantity of mineral products is required for MINERALS to be as conductive as SALT. This varies from supplier to supplier so always refer to their suggested amounts to be added to your pool.

Pressing [OK] confirms your selection.

Pressing [<] returns you to the previous menu screen.

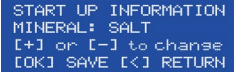

```
START UP INFORMATION
MINERAL: SALT
[+] or [-] to change
[OK] SAVE [<] RETURN
```

## 5.6 Default Display Screen

DEFAULT DISPLAY SCREEN (DDS) displays the screen to the right. This is the actual output % of the unit.

Pressing [+] or [-] will increase the Output setting and the screen will change as seen on the right. This should always remain at 100% unless SPA MODE has been selected.

The (●) symbol indicates normal operation.

T2 is the default timer displaying "Dual Timer Cycle" and T1 displays "Single Timer Cycle" when single timer is selected.

The Mode shows AUTO, and this can be changed by pressing Power/Mode (either AUTO, ON or OFF).

The time shows as HH:MM in 24hr clock format.

The cell status shows as FWD when the cell is in the forward direction and REV when in the reverse direction.

The pump AC socket status is displayed, either ON or OFF.

The Water Temperature is displayed.

Any power failures return you to the DDS screen and the last saved MODE is active.

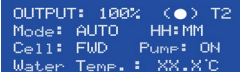

```
OUTPUT: 100% (●) T2
Mode: AUTO   HH:MM
Cell: FWD    Pump: ON
Water Temp. : XX.X°C
```

**Please note: To extend the life of the LCD display, the display will become dim after 2 minutes of inactivity. Any time you press the keypad, the LCD will become bright again, and automatically dim once the activity has stopped after 2 minutes.**

# 6. CONTROL PANEL OPERATION

## 6.1 OK BUTTON

Menus are entered by either pressing the menus shortcut button on the control panel or by entering MAIN MENU, which is done by pressing the [OK] button. Any inactivity in any display for longer than 60 seconds results in the display returning to the DDS screen.

MAIN MENU allows you to enter all MENU's including those available with shortcut buttons on the control panel.

Pressing [+] takes you to the last menu and using the [-] or [OK] enters the first 3 menus.

Pressing [<] returns you to the previous menu screen.

Pressing [+] or [-] scrolls up or down and [OK] enters the flashing menu.

Below are the available menus in the VAPURE VP-Series Salt Chlorinator.

**See 7.0 for the workings of any menu's not explained here.**

- |                 |                        |
|-----------------|------------------------|
| 1 Backwash      | 8 Power/Mode           |
| 2 Brightness    | 9 Pump Setting         |
| 3 Cell Cleaning | 10 Salt Test           |
| 4 Chlor Boost   | 11 Service Menu        |
| 5 Chlor Setting | 12 Spa Mode            |
| 6 Clock/Timer   | 13 Winter/Blanket Mode |
| 7 Contrast      | 14 pH Control Mode     |

MAIN MENU  
Simply use buttons  
[+] or [-] to change  
[OK] ENTER [<] EXIT

OUTPUT: 100% (●) T2  
Mode: AUTO HH:MM  
Cell: FWD Pump: ON  
Water Temp.: XX.X°C

1 Backwash  
2 Brightness  
3 Cell Cleaning  
[+][UP][-]DN[OK]ENTER

11 Service menu  
12 Spa Mode  
13 Winter Mode  
[+][UP][-]DN[OK]ENTER

13 Winter Mode  
[+][UP][-]DN[OK]ENTER



# 6. CONTROL PANEL OPERATION

## 6.2 POWER/MODE

[POWER/MODE] button changes the operating modes of your VAPURE VP-Series Salt Chlorinator. When pressed the Mode will change from AUTO to OFF then ON. When the unit is first powered on, the factory setting is in AUTO as shown to the right.

```
OUTPUT: 100% (●) T2
Mode: AUTO  HH:MM
Cell: FWD  Pump: ON
Water Temp. : XX.X°C
```

Pressing [POWER/MODE] to OFF will display the screen as seen to the right.

```
OUTPUT: 0% (●) T2
Mode: OFF  HH:MM
Cell: OFF  Pump: OFF
UNIT TURNED OFF
```

Pressing [POWER/MODE] to ON will display the screen as seen to the right.

```
OUTPUT: 100% (●) T2
Mode: ON  HH:MM
Cell: FWD  Pump: ON
Water Temp. :XX.X°C
```

Pressing [OK] from the DDS screen enters the MAIN MENU. Pressing [+] takes you to the last menu and using the [-] or [OK] enters the first 3 menus.

```
MAIN MENU
Simply use buttons
[+] or [-] to change
[OK] ENTER [←] EXIT
```

Pressing [←] returns you to the DDS screen.

Pressing [+] takes you to the last menu. Pressing [+] 5 times above displays the display shown to the right. Press [OK] to enter [POWER/MODE]. Pressing [OK] enters the display shown to the right and pressing the [+] or [-] allows you to adjust the [POWER/MODE] setting from AUTO to OFF to ON. Pressing [OK] saves the required mode and returns to the previous screen. Pressing [←] returns you to the DDS screen.

```
7 Contrast
8 Power/Mode
9 Pump Setting
[+]JUPL[-]DN[OK]ENTER
```

```
POWER / MODE
Setting: AUTO
[+] or [-] to change
[OK] SAVE [←] BACK
```

## 6.3 CHLOR BOOST

**BEFORE ENTERING CHLOR BOOST YOU MUST BE IN THE DDS SCREEN.**

[CHLOR BOOST] button sets your VAPURE VP-Series Salt Chlorinator and pump to operate for 8hrs and automatically sets the chlorine setting to 100%. This allows for an injection of extra sanitising time, also known as Chlorine Boost or Super-Chlorinate. The bottom line will alternate between "[CHLOR BOOST] to END" and the fault message if there is any fault during CHLOR BOOST.

```
CHLOR BOOST TIME
Setting: 08:00:00hrs
[+] or [-] to change
[CHLOR BOOST] to END
```

After the set time, the chlorinator reverts to the last selected POWER/MODE unless it is in ON Mode then it reverts to AUTO.

The unit automatically defaults to 08:00 hours of ON time and the timer starts counting down immediately. The first two digits **08** will flash while adjusting them, as shown to the right. Pressing [+] or [-] increases or decreases in increments of 01:00 hrs. whilst running.

When completed the unit will return to the DDS screen in the last selected POWER/MODE state and the CHLOR BOOST LED goes OFF.

Pressing [CHLOR BOOST] again allows you to exit the CHLOR BOOST screen and return to the DDS screen.

CHLOR BOOST can also be entered by pressing the [OK] button in MAIN MENU and scrolling to CHLOR BOOST.

# 6. CONTROL PANEL OPERATION

## 6.4 WINTER/BLANKET MODE

**BEFORE ENTERING WINTER/BLANKET MODE, YOU MUST BE IN THE DDS SCREEN.**

[WINTER/BLANKET] button automatically turns your VAPURE VP-Series Salt Chlorinator setting (Chlor Setting) down by 50% when the unit is either in AUTO or ON mode. The unit defaults to a 50% setting and will stay on this until [WINTER/BLANKET] is pressed again.

Pressing [+] or [-] increases or decreases this 50% setting by increments of 10% from 0% to 90%.

Once your desired setting is entered, pressing [OK] will return to the DDS screen and the output will display at the lowered setting (50% or different if you set it to that).

Pressing [WINTER/BLANKET] whilst ON automatically turns this LED off and the unit returns to a setting of 100%.

If you need to adjust running times during winter, pressing [CLOCK/TIMER] will allow you to adjust operating times of the unit if necessary. **See 6.5 CLOCK/TIMER** for more detail or contact your local pool Professional for further assistance.

WINTER/BLANKET MODE can also be entered by pressing the [OK] button in MAIN MENU and scrolling to WINTER/BLANKET MODE.

```
WINTER MODE OUTPUT
Setting: 50%
[+] or [-] to change
[OK] SAVE [<] EXIT
```

## 6.5 CLOCK/TIMER

**BEFORE ENTERING THE CLOCK/TIMER YOU MUST BE IN THE DDS SCREEN.**

Your VAPURE VP-Series unit comes with a built-in digital timer. CLOCK /TIMER displays are all shown in 24-hour format.

[CLOCK/TIMER] button allows you to set the CLOCK and run TIMER times of the chlorinator.



**It is important to understand the difference between CLOCK and TIMER**  
**CLOCK, Clock means the physical time of the day (e.g., 08:00) and TIMER**  
**means the settings programmed to turn the unit ON and OFF**

**To run the chlorinator in MANUAL ON (i.e., always ON): Mode set to: ON**  
**T1 & T2 ON & OFF set to 00:00**

CLOCK SETTING allows you to program the exact time of the day.

### 6.51 Clock Settings

HH digits flash and pressing [+] increases the time and [-] decreases the time.

Pressing [OK] accepts the selected hour HH.

Pressing [<] exits you to the DDS screen.

MM digits flash and pressing [+] increases the time and [-] decreases the time.

Pressing [OK] accepts the selected minute MM.

Pressing [<] returns you to the previous display.

Obviously, sunlight and higher bather loads in summer dissipate more chlorine than in winter. That is why you need to check your chlorine reading regularly and adjust your settings when required.

```
CLOCK SETTING
ACTUAL TIME:  HH:MM
[+] or [-] to change
[OK] SAVE [<] EXIT
```

```
CLOCK SETTING
ACTUAL TIME:  HH:MM
[+] or [-] to change
[OK] SAVE [<] RETURN
```



# 6. CONTROL PANEL OPERATION



## Summer Settings

Ideally, run for 4 hours in the morning (6am-10am) and 4 hours in the evening (4pm-8pm). For a smaller pool you can run less hours. In extreme weather it may be necessary to run longer hours. Contact your local pool Professional for further assistance.



Winter Settings See 6.4 WINTER MODE for more detail.

## 6.52 Timer Settings

Pressing [CLOCK/TIMER] displays the screen to the right.  
Pressing [+] then changes the timer to the Single Timer Cycle (T1).  
Pressing [OK] accepts the selected cycle and enters the Timer Program.  
To program the actual time of the day press [CLOCK/TIMER] again.

```
HH:MM - DUAL CYCLE
[+] to change cycle
[OK] confirms cycle
[CLOCK] to set clock
```

Pressing [+] changes back to Dual Timer Cycle (T2).  
Pressing [OK] accepts the selected cycle and enters the Timer Program.  
To program the actual time of the day press [CLOCK/TIMER] again.

```
HH:MM - SINGLE CYCLE
[+] to change cycle
[OK] confirms cycle
[CLOCK] to set clock
```

TIMER 1: ON TIME (HH)  
HH digits flash and pressing [+] increases the time and [-] decreases the time.  
Pressing [OK] accepts the selected hour HH.  
Pressing [<] returns you to the previous display.

```
TIMER 1: ON TIME
START TIME:  HH:MM
[+] or [-] to change
[OK] SAVE [<] RETURN
```

TIMER 1: ON TIME (MM)  
MM digits flash and pressing [+] increases the time and [-] decreases the time.  
Pressing [OK] accepts the selected minute MM.  
Pressing [<] returns you to the previous display.

```
TIMER 1: ON TIME
START TIME:  HH:MM
[+] or [-] to change
[OK] SAVE [<] RETURN
```

TIMER 1: OFF TIME (HH)  
HH digits flash and pressing [+] increases the time and [-] decreases the time.  
Pressing [OK] accepts the selected hour HH.  
Pressing [<] returns you to the previous display.

```
TIMER 1: OFF TIME
STOP TIME:   HH:MM
[+] or [-] to change
[OK] SAVE [<] RETURN
```

TIMER 1: OFF TIME (MM)  
MM digits flash and pressing [+] increases the time and [-] decreases the time.  
Pressing [OK] accepts the selected minute MM.  
Pressing [<] returns you to the previous display.

```
TIMER 1: OFF TIME
STOP TIME:   HH:MM
[+] or [-] to change
[OK] SAVE [<] RETURN
```

TIMER 2: ON TIME (HH)  
HH digits flash and pressing [+] increases the time and [-] decreases the time.  
Pressing [OK] accepts the selected hour HH.  
Pressing [<] returns you to the previous display.

```
TIMER 2: ON TIME
START TIME:  HH:MM
[+] or [-] to change
[OK] SAVE [<] RETURN
```

TIMER 2: ON TIME (MM)  
MM digits flash and pressing [+] increases the time and [-] decreases the time.  
Pressing [OK] accepts the selected minute MM.  
Pressing [<] returns you to the previous display.

```
TIMER 2: ON TIME
START TIME:  HH:MM
[+] or [-] to change
[OK] SAVE [<] RETURN
```

TIMER 2: OFF TIME (HH)  
HH digits flash and pressing [+] increases the time and [-] decreases the time.  
Pressing [OK] accepts the selected hour HH.  
Pressing [<] returns you to the previous display.

```
TIMER 2: OFF TIME
STOP TIME:   HH:MM
[+] or [-] to change
[OK] SAVE [<] RETURN
```

TIMER 2: OFF TIME (MM)  
MM digits flash and pressing [+] increases the time and [-] decreases the time.  
Pressing [OK] accepts the selected minute MM.  
Pressing [<] returns you to the previous display.

```
TIMER 2: OFF TIME
STOP TIME:   HH:MM
[+] or [-] to change
[OK] SAVE [<] RETURN
```

# 6. CONTROL PANEL OPERATION

## 6.6 SALT TEST

**BEFORE ENTERING SALT TEST, YOU MUST BE IN THE DDS SCREEN.**

[SALT TEST] button measures the salt level in your swimming pool. A reading will appear on the screen, allow at least 30 seconds for an accurate reading.

**BEFORE PERFORMING A SALT TEST, ENSURE THE CELL IS CLEAR OF ANY CALCIUM DEPOSITS, AS THIS WILL INSULATE THE ELECTRODES AND IMPACT YOUR READINGS. See 9.1 Inspecting and Cleaning the Cell Electrode if manual cleaning is required.**

By pressing [SALT TEST] a salt measurement is taken and a range is displayed, an approximate TDS reading is indicated immediately after, and these measurements will alternatively scroll until the [SALT TEST] button is pressed again and returns to the DDS.

The ideal TDS reading should be "OK", approximately 3500-4000 ppm.

If "HIGH" is displayed, the salt level is above 4500 ppm and the salt level is too high, and we suggest taking a sample to your local pool Professional for a more accurate result and further assistance.

Similarly, if the display indicates "LOW" take a sample of pool water to your pool Professional for more accurate results and advice. For the freshwater low salt system Models: VP25LS and VP35LS, the ideal or "OK" TDS reading is 1500-1800 ppm.

Low salt levels (below 1000 ppm) and high salt levels (above 8000 ppm) are difficult to measure, and results may become inaccurate. It may be that your cell needs replacing, contact your local pool Professional for a more accurate result and further assistance.

The SALT TEST measurement is meant to be a guide only as many factors can impact the result. We recommend you take your pool water sample to your local pool Professional before adding salt/minerals or replacing your Cell.

**NEVER** add more salt if not required. **NEVER** add salt directly to the skimmer box.

**SALT TEST can also be entered by pressing the [OK] button in MAIN MENU and scrolling to SALT TEST.**

SALT TEST MODE  
SALT : OK  
[SALT TEST] to END

SALT TEST MODE  
SALT : HIGH  
Consult a Pool Shop  
[SALT TEST] to END

SALT TEST MODE  
SALT : LOW  
Consult a Pool Shop  
[SALT TEST] to END

SALT TEST MODE  
Approximate TDS  
Level is:XXXXX PPM  
[SALT TEST]to END

## 6.7 BACKWASH

**BEFORE ENTERING BACKWASH MODE, YOU MUST BE IN THE DDS SCREEN.**

[BACKWASH] button assists you in the operation of your pump and filter during the backwash process.



**IMPORTANT INFORMATION BEFORE PERFORMING A BACKWASH.**

**NEVER OPERATE THE FILTER LEVER WHILE THE PUMP IS RUNNING YOU MAY DAMAGE THE SEAL AND LEAKS MAY OCCUR.**

**THE PUMP WILL START AND STOP AS YOU REQUIRE.**

**ENSURE ALL THE VALVES, VALVE HANDLE, LIDS, BASKETS, ETC. ARE IN THE IN THE CORRECT POSITIONS AS PER THE REQUIREMENTS OF THE MANUFACTURERS OF THAT EQUIPMENT.**

[BACKWASH] can also be entered by pressing the [OK] button in the MAIN MENU and scrolling to BACKWASH MODE.

# 6. CONTROL PANEL OPERATION

ALWAYS FOLLOW THE FILER MANUFACTURERS INSTRUCTIONS.

If unsure, perform BACKWASH manually by pressing [POWER/MODE] ON & OFF to perform the filter clean.

During BACKWASH the unit displays the ON LED when the pump is running and the OFF LED displays when the pump is stopped.

Set the multiport valve to Backwash. Pressing [OK] starts the pump for 2 minutes and TIME LEFT will be displayed automatically counting down in 1 sec increments. If you wish to increase the backwash time, use the [+] or to stop the pump press the [-] button, and then the [+] button to restart or if the dirty water in the waste pipe or sight glass is clear press [OK] to finish. RINSE MODE will then be displayed.

Pressing [OK] stops the pump and RINSE MODE is displayed. Rotate the filter multi-port valve to the rinse position, ensure the handle locks in place and once ready press [OK] to enter the RINSE MODE cycle. Pressing [<] or [BACKWASH] allows you to exit and this takes you to BACKWASH COMPLETE.

Pressing the [OK] button starts the pump for 2 minutes. TIME LEFT automatically starts counting down in 1 sec increments. Once dirty water in the waste pipe or sight glass is clear then press [OK] to finish RINSE MODE and enter BACKWASH COMPLETE MODE.

Pressing [OK] stops the pump and BACKWASH COMPLETED is displayed. Rotate the filter multi-port valve to the filter position, ensure the handle locks in place and once ready press [BACKWASH] to finish the backwash and exit to the default display screen.

```
BACKWASH MODE
Set MPValve to Back-
Wash and press
[OK] NEXT [<] EXIT
```

```
BACKWASH MODE
[+] Add 1min to TIME
[-]Stop Pump[OK]NEXT
TIME LEFT: 02:00 min
```

```
RINSE MODE
Set MPValve to Rinse
Position and press
[OK] NEXT [<] EXIT
```

```
RINSE MODE
[+] Add 1min to TIME
[-]Stop Pump[OK]NEXT
TIME LEFT: 1:00 min
```

```
BACKWASH COMPLETED
Set MPValv to Filter
position and press
[OK] NEXT [<] EXIT
```

```
BACKWASH COMPLETED
Final check on all
valves/lid positions
[BACKWASH] to EXIT
```

# 7. UNIT MENU GUIDE

## 7.1 Backwash

See 6.7 BACKWASH (CONTROL PANEL OPERATION)

## 7.2 Brightness

BRIGHTNESS is entered by pressing the [OK] button in the MAIN MENU and scrolling to BRIGHTNESS (Menu 2).

The factory setting is 60%.

Pressing [+] or [-] allows you to adjust the BRIGHTNESS. Pressing [OK] saves the selection.

```
BRIGHTNESS MODE
Setting: 60%
[+] or [-] to change
[OK] SAVE [<] BACK
```

## 7.3 Cell Cleaning

Smart self-cleaning technology allows the polarity of the OXI Cell plates to change direction every 4-16hrs (depending on your setting). The change of polarity causes the calcium to dislodge and keep the OXI plates clean. Please note occasional cleaning of the plates may be necessary.

The factory setting is every 10 hours, and this can be adjusted from as low as 4 hours (for high calcium areas) and as high as 16 hours.

In areas where the calcium hardness of the water is low (less than 200 ppm) cleaning of the cell may not be necessary.

Where calcium levels exceed 200 ppm, regular inspection of the cell is necessary. Cleaning in an acid solution may be necessary.

CELL CLEANING is entered by pressing the [OK] button in the MAIN MENU and scrolling to CELL CLEANING.

```
CELL REVERSING TIME
Setting: XX hours
[+] or [-] to change
[OK] SAVE [<] BACK
```

## 7.4 Chlor Boost

See 6.3 CHLOR BOOST (CONTROL PANEL OPERATION)

## 7.5 Chlor Setting

CHLOR SETTING automatically controls the Chlorine output for your VAPURE VP-Series Salt Chlorinator.

This feature is particularly handy when you want to run the pump for longer hours (i.e., maybe with a variable speed pump or you want additional filtration). If this is the case the levels would be decreased.

The factory setting is set to 100%.

Pressing [+] or [-] anytime whilst in the DDS screen increases or decreases in 1% increments.

CHLOR SETTING is entered by pressing the [OK] button in the MAIN MENU and scrolling to CHLOR SETTING (Menu 5).

## 7.6 Clock/Timer

See 6.5 CLOCK/TIMER (CONTROL PANEL OPERATION)

# 7. UNIT MENU GUIDE

## 7.7 Contrast

CONTRAST is entered by pressing the [OK] button in the MAIN MENU and scrolling to CONTRAST (Menu 7).

The contrast can be set to any value from 20% to 100%. The default setting is 50%.

Pressing [+] or [-] allows you to make the CONTRAST adjustment and pressing [OK] saves the required CONTRAST and returns to the DDS screen.

```
CONTRAST MODE
Setting: 50%
[+] or [-] to change
[OK] SAVE [<] BACK
```

## 7.8 Power/Mode

See 6.2 POWER/MODE (CONTROL PANEL OPERATION)

## 7.9 Pump Setting

PUMP SETTING is designed to protect your pump if there is no flow of water. This means the time the pump is allowed to run after the water sensor on the Cell detects there is no flow of water. The pump will be turned off from 3 to 10 minutes, after detecting no water flow.

PUMP SETTING is entered by pressing the [OK] button in the MAIN MENU and scrolling to PUMP SETTING (Menu 9).

The default setting is 3 minutes and pressing [+] or [-] allows you to adjust the time the pump is turned off for. Pressing [OK] saves the required protection time.

You can also select OFF and it will be disabled and will not stop the pump outlet.

```
PUMP PROTECTION
Setting: XXX minutes
[+] or [-] to change
[OK] SAVE [<] BACK
```

## 7.10 Salt Test

See 6.6 SALT TEST (CONTROL PANEL OPERATION)

## 7.11 Service Menu

There are several operations that can be undertaken in the service menu including the use of an external controller and operation of your swimming pool pump to circulate water in the pool without chlorine production by the Vapure Salt and Mineral Chlorinator.

### EXTERNAL CONTROLLER

If you need to set the Chlorinator to remain ON all the time, such as when you are using an external controller, then you can do it in this menu setting.

You can access this function by pressing the [OK] button to enter the MAIN MENU and scrolling to SERVICE MENU (Menu 11), using the [+] or [-] buttons.

To access the EXTERNAL CONTROLLER MENU, scroll through the SERVICE MENU using the [+] or [-] buttons until you reach menu S10 EXTERNAL CONTROLLER. Then press [OK] to enter the display on the right.

The default setting is OFF. Pressing [+] or [-] allows you to adjust the setting from OFF to ON. Pressing [OK] saves the required setting.

The default display screen (DDS) will now display EX at the top right corner, indicating that the external control function is activated.

```
EXTERNAL CONTROLLER
Setting: OFF
[+] or [-] to change
[OK] SAVE [<] EXIT
```

```
OUTPUT: 100% (<>) EX
Mode: ON    HH:MM
Cell: FWD  Pump: ON
Water Temp: XX.X° C
```

# 7. UNIT MENU GUIDE

## PUMP RUN TIME

To access the PUMP RUN TIME MENU, scroll through the SERVICE MENU using the [+] or [-] buttons until you reach menu S11 PUMP RUN TIME.

Press [OK] to enter the display on the right. This allows you to set a single pump run event [1. PUMP SINGLE RUN] or a permanent additional pump running time [2. PUMP ON TIMERS]. Use the [+] or [-] buttons to select the function required and press [OK] to enter or [<] to return to the previous menu.

```
1. PUMP SINGLE RUN
2. PUMP ON TIMERS
[+] or [-] to change
[OK]ENTER [<] RETURN
```

### Pump Single Run:

This can be used to circulate water in the pool without chlorine production by the Chlorinator. This is mostly used by service technicians when adding salt to the pool or if additional filter time is needed after a pool service.

Pressing [OK] on the display above at [1. PUMP SINGLE RUN] takes you to the display shown to the right. This message makes you aware that the cell does not work during this time. Press [OK] to ENTER the PUMP SINGLE RUN and press [<] allows to exit and return to the previous display.

```
PUMP SINGLE RUN
NOTE: Cell is not ON
during this time.
[OK]ENTER [<] RETURN
```

Pressing [OK] on the PUMP SINGLE RUN menu takes you to the display shown to the right. The [+] or [-] allows you to adjust the PUMP RUN TIME from 1 to 24 hours in increments of one hour. The default run time is 8 hours.

```
PUMP SINGLE RUN
Setting: 08:00:00hrs
[+] or [-] to change
[OK]START [<] RETURN
```

Once the time is set then press [OK] to START the pump and this takes you to the following display. Pressing [<] allows you to exit and return to the service menu without saving any changes.

NOTE: The CELL will be OFF during this time even if T1 and T2 times are calling for the cell to be ON.

The display to the right will show you the PUMP RUN TIME LEFT in real time. If the operator presses [OK] to STOP this function, the display will return to the DDS and the chlorinator will return to its previous operating mode.

```
PUMP RUN TIME LEFT
Time Left:08:00:00hr
[+] or [-] to change
[OK] STOP
```

### Pump On Timers:

This is typically used if you have a heat pump or energy efficient pump, and you need to run the pump for longer hours than the cell.

Pressing [OK] on display [2. PUMP ON TIMERS] takes you to the display shown to the right.

NOTE: The pump will run outside of T1 and T2 times. The cell will be OFF when outside of the T1 and T2 times. Overlapping P1/P2 and T1/T2 times means the pump will be ON for all P1/P2 times and the cell will only be ON for the T1/T2 times.

```
PUMP ON TIMERS
This runs PUMP only
outside T1,T2 times.
[OK] ENTER [<] RETURN
```

Pressing [OK] on the above display will enter the [PUMP P1: ON TIMER] display on the right. The HH digits flash and pressing [+] increases the time and [-] decreases the time. Pressing [<] allows you to return to the previous menu without saving any changes.

```
PUMP P1: ON TIMER
START TIME: HH:MM
[+] or [-] to change
[OK] SAVE [<] RETURN
```

Pressing [OK] accepts the selected hour HH and takes you to the following display to set the minutes required. The MM digits will now flash and pressing [+] increases the time in minutes and pressing the [-] will decrease the time. Press [OK] to accept the selected minutes, this will take you to the next display. Pressing [<] returns you to the previous display. Pressing [<] returns you to the previous menu.

```
PUMP P1: ON TIMER
START TIME: HH:MM
[+] or [-] to change
[OK] SAVE [<] RETURN
```

## 7. UNIT MENU GUIDE

After Selecting [OK] in display [PUMP P1: ON TIMER] the unit will display the [PUMP P1: OFF TIMER] to the right. The HH digits flash and pressing [+] increases the time and [-] decreases the time.

Pressing [OK] accepts the selected hour HH and takes you to the next display to set the minutes. Pressing [<] returns you to the previous display.

The MM digits will now flash and pressing [+] increases the time and [-] decreases the time. Pressing [OK] accepts the selected minutes MM and takes you to the next display to set the [PUMP P2: ON TIMER]. Pressing [<] returns you to the previous display.

The [PUMP P2: ON TIMER] display on the right will show, and the same steps can be followed as above to set the PUMP P2: ON and OFF times.

Pressing [OK] at the end of setting [PUMP P2: OFF TIME] MM will take you back to the DDS. Pressing [<] returns you to the previous display.

**NOTE:** By default, the P1 and P2 ON & OFF times are 00:00. If P1 or P2 times are set to 00:00 then nothing happens. 00:00 is ignored by the system.

```
PUMP P1: OFF TIMER
STOP TIME:   HH:MM
[+] or [-] to change
[OK] SAVE [<] RETURN
```

```
PUMP P1: OFF TIMER
STOP TIME:   HH:MM
[+] or [-] to change
[OK] SAVE [<] RETURN
```

```
PUMP P2: ON TIMER
START TIME:  HH:MM
[+] or [-] to change
[OK] SAVE [<] RETURN
```

```
PUMP P2: OFF TIMER
STOP TIME:   HH:MM
[+] or [-] to change
[OK] SAVE [<] RETURN
```

### 7.12 Spa Mode

SPA MODE allows your unit to be adjusted to suit your spa.

SPA MODE is entered by pressing the [OK] button in the MAIN MENU and scrolling to SPA MODE (Menu 12).

Pressing [+] or [-] allows you to adjust the SPA MODE settings from OFF to ON and ON to OFF.

Selecting the OFF setting leaves the OUTPUT SETTING at 100% and ON changes the OUTPUT SETTING to 10%.

When SPA MODE is selected, the DDS screen will change as shown to the right.

Pressing [OK] saves the required settings and returns to the DDS Screen.

```
SPA MODE
Setting: OFF
[+] or [-] to change
[OK] SAVE [<] BACK
```

```
OUTPUT: 10% (●) T2
Mode: SPA   HH:MM
Cell: FWD   Pump: ON
Water Temp. : XX.X°C
```

### 7.13 Winter/Blanket Mode

See 6.4 WINTER/BLANKET MODE (CONTROL PANEL OPERATION)

### 7.14 pH Control Mode

The default setting on your VAPURE VP-Series Salt Chlorinator is for the acid dosing system to be OFF. pH CONTROL MODE needs to be turned on to operate the pH Logix System.

pH CONTROL MODE is entered by pressing the [OK] button on the main menu and scrolling to pH CONTROL MODE (menu 14). Pressing [+] or [-] allows you to adjust the pH MODE settings from OFF to ON and ON to OFF. Press [OK] to SAVE the selection.

```
pH CONTROL MODE
pH Mode: ON
[+] or [-] to change
[OK] SAVE [<] BACK
```

# 7. UNIT MENU GUIDE

pH1 Run Time is programmed automatically when setting up the volume of the swimming pool in the chlorinator. The system calculates how many minutes per day your pH controller should run based on the volume of your pool, and this can be manually changed.

```
pH CONTROL MODE
pH1 Run Time
pH2 Demand or Prime
[+]JUPE[-]DN [←] BACK
```

To adjust the pH1 Run Time enter the Main Menu by pressing the [OK] button and scrolling to pH Control Mode (Menu 14), then select pH1 Run Time.

The LCD will now show 'On Time: --- min/day'.

Press [+] or [-] to adjust the ON Time in min/day.

Pressing [←] returns to the previous pH CONTROL MODE menu.

Pressing [OK] saves the required run time and returns to you to the main menu.

Saving this Run Time will result in the time being saved as the new daily default running time of the unit.

```
pH1 RUN TIME
ON Time: 20 min/day
[+] or [-] to change
[OK] SAVE [←] BACK
```

**NOTE: Some states use undiluted hydrochloric acid to feed the pH controller (i.e., there is no container with a 1:3 mix). In this case, the operator needs to manually change the run time in Menu 'pH1 Run Time' from the displayed result to approximately ¼ of this reading (i.e., if 15min/day is displayed then change this to 4min/day by following the instruction above).**

**If you are using a low-fuming type of acid, such as 32% sulphuric acid, then you may need to double the run time as its ability to lower the pH is less than that of hydrochloric acid. Once again, you need to test your water weekly until you reach the optimum setting for your system.**

The 'pH2 DEMAND or PRIME' quantity can be manually adjusted from 0 - 5000 ml. The default reading is always 100 ml. This function is useful for Priming tubes after an acid drum change or adding the required acid from your acid demand test.



**IMPORTANT:** Enter the exact amount from your test result in ml (e.g., 500ml) and the system automatically adds 4 times that amount, thereby allowing for the 1:3 ACID: WATER mix ratio in the acid drum.

To select the 'pH DEMAND or Prime' function, enter the main menu by pressing the [OK] button and scrolling to 'pH Control Mode' (Menu 14), then select 'pH2 Demand or Prime'. Press [+] or [-] to adjust the quantity of acid required in millilitres (ml).

```
pH2 DEMAND or PRIME
Acid Demand: 100 ml
[+] or [-] to change
[OK] SAVE [←] BACK
```

Pressing [OK] saves the required quantity, the peristaltic pump starts turning and a time-based reading (in minutes) starts counting down.

You can lower the time by pressing [-] menu if you wish.

Pressing [←] returns to the previous pH CONTROL MODE menu.

Pressing [OK] saves the required run time and returns to you to the main menu. If the lines are primed, you can stop the peristaltic pump by pressing [-], while in the 'pH2 DOSE TIME LEFT' menu, to lower the 'Time Left:' to 0 min.

```
pH2 DOSE TIME LEFT
Time Left: 48 min
[-] to lower Time
[OK] SAVE [←] RETURN
```

**NOTE: Some states use undiluted acid to feed the pH controller (i.e., there is no container with a 1:3 mix). In this case the operator needs to manually change the dose time in Menu 'pH1 DOSE TIME LEFT' from the displayed result to an approximate ¼ of this reading (i.e., if 48 min is displayed then change this to 12 min by following the instruction above).**

To turn OFF the acid dosing, press the [OK] button on the main menu and scroll to pH CONTROL MODE (menu 14). Press [OK] on the 'pH mode: ON' menu from 'pH Control Mode'. Then use the [+] or [-] button to change the selection from ON to OFF and press [OK] to save.



## 8. WATER CHEMISTRY



The VAPURE VP-Series Salt Chlorinator unit is designed for use with swimming pool water balanced in accordance with the Langelier Saturation Index with a pH range of 6.8-7.8.

As previously advised, for the best performance and operation of your VAPURE VP-Series Salt Chlorinator unit, certain water balances must be maintained within your swimming pool. Have your water tested regularly. Transport the test water in an opaque container and have the test done as soon as possible for the best results.

### 8.1 Chlorine

**Measurement Interval: Once a week**

Ideal Chlorine (Free Chlorine) Levels: 2-3 ppm (2-3 mg/L) and no more than 4 ppm (4 mg/L). Adjust the chlorine output by pressing [+] in DDS to increase the required output setting in 1% increments up to 100%. Pressing [-] will decrease the output in 1% increments to 0%. Running the unit for longer or shorter hours can achieve the same result.

### 8.2 Salt

**Measurement Interval: Every 4-6 weeks**

Salt Levels: 3500-4000 ppm (3500 ppm ideal) and no more than 4500 ppm. For the FRESHWATER/ULTRA-LOW SALT SYSTEM Models: VP15LS, VP25LS and VP35LS, the ideal TDS reading is 1500-1800 ppm (1500 ppm ideal).

Although salt is not consumed by the Chlorinator, salt is lost during backwashing, pool overflow, splashing and on bathers that use it. The correct salt level allows for the most efficient production levels and electricity consumption.

The salt level **SHOULD NOT** go below 3000 ppm or 1200 ppm for the VP15LS, VP25LS and VP35LS models. Operating the unit with too little salt in the pool will cause damage to your Cell.

Salt is the essential element by which your unit operates. Not enough salt means not enough chlorine - this simple rule governs the total operation of your VAPURE VP-Series Salt Chlorinator unit, and insufficient salt will damage your Cell. Use Ultrafine Salt or Premium Salt to keep optimum salt levels.

The unit will operate with good stability on higher salt levels, but it is still advisable to run at the correct level to prevent damage. Salt levels above 5000 ppm or 2500 ppm in the VP15LS, VP25LS and VP35LS models may overload the unit and cause excessive heat.



**NEVER ADD SALT DIRECTLY TO THE SKIMMER BOX.** This high concentration of salt will pass through your filtration, pump, and other pool equipment.

**HANDY TIP:** The colder the water, the lower your output, but this does not mean you need more salt. There will always be less chlorine demand in colder water.

We recommend 3.5 kg per 1000 litres of pool water and a 50,000lt new pool needs approximately 175 kg of salt. For the FRESHWATER LOW SALT SYSTEM Models: VP15LS, VP25LS and VP35LS, we recommend 1.5 kg per 1000 litres of pool water.

The unit can operate on mineral/magnesium chloride salts, and you should allow an extra 20-30% more product to achieve the correct TDS for your unit to run efficiently.

Salt should always be added to the shallow end of the pool and allowed to dissolve. Do not let the salt settle on the floor of the pool as this may cause damage to the surface. Use your pool brush to mix the salt into the water.

Running the pump will mix the water and help the salt to dissolve.



**Low salt levels (<1000 ppm) will destroy the coating on the Cell and void the warranty.**

## 8. WATER CHEMISTRY

### 8.3 pH

**Measurement Interval: Once a week**

Ideal pH Levels:        Concrete Pools: 7.4 - 7.6  
                                 Fibreglass/Vinyl Pools: 7.0 - 7.2

A pH of 8.0 makes oxidization only about 26% efficient which is why it is critical to keep your pH in range.

A correct pH level must be maintained to prevent problems such as black spots, staining, cloudy water, etc. An incorrect pH level can damage the surface finish and walls of your pool.

When pH is high you can add Hydrochloric Acid to lower the pH.  
When pH is low you can add pH Increaser - sodium bicarbonate (soda ash) to increase the pH.

### 8.4 Total Alkalinity

**Measurement Interval: Every 4-6 weeks**

Ideal Total Alkalinity Levels:        Concrete Pools: 80 – 150 ppm  
   Fibreglass/Vinyl Pools: 80 – 120 ppm

Total Alkalinity should not be confused with pH, although the two are closely related. Total Alkalinity determines the speed and ease of pH change, it is measured in ppm. You should use a test kit which includes a test for Total Alkalinity. Low Total Alkalinity can cause unstable pH levels. This causes an inability to keep the pH constant and may cause staining, etching and corrosion of metals. High Total Alkalinity will cause constantly high pH levels.

When Total Alkalinity is high you can add Hydrochloric (a little at a time) to lower the Total Alkalinity. When Total Alkalinity is low you can add pH Increaser - sodium bicarbonate to raise the Total Alkalinity.

Ideal Calcium Hardness Levels: Concrete Pools: 250 – 300 ppm

### 8.5 Calcium Hardness

**Measurement Interval: Every 3 months**

Fibreglass/Vinyl Pools: 150 – 190 ppm

In addition to pH and Total Alkalinity, Calcium Hardness must be kept in balance so that your pool water does not become too corrosive or end up scaling the surface of your pool. These conditions are symptoms of swimming pool water that is unbalanced.

### 8.6 Stabiliser

**Measurement Interval: Every 4-6 weeks**

Ideal Stabiliser Levels: 30 – 70 ppm

The importance of pool Stabiliser cannot be over emphasised. It is essential in helping retain chlorine in your pool. Chlorine is rapidly dissipated by sunlight and the use of Stabiliser will reduce this dissipation dramatically. Without a Stabiliser, it may be necessary to run the unit for longer hours.



THE MOST IMPORTANT NOTICE AND WARNING:

Only add chemical in the method and quantities as indicated on the packaging provided or advised by your local pool Professional. Also, if in doubt of any results you achieve then do not hesitate to consult with your local pool Professional.

## 9. CHLORINATOR MAINTENANCE

Maintenance of your VAPURE VP-Series Salt Chlorinator is simple. Your unit must be one of the most productive pieces of equipment in your swimming pool, so it requires some basic maintenance.

While water chemistry will always be the most important form of maintenance there are also other hints and pointers to take note of.

**DO NOT** cover the Power Pack with towels or similar. There are vents that could be closed and these need air to keep the unit cool.

To extend the life of your unit we always recommend installation in an undercover area away from the elements.

Placing the unit in a closed shed or similar environment with chemicals, fertilisers and other corrosives will damage the unit and could void your warranty.

Always keep the chlorinator off whilst backwashing your sand filter. Please remember to turn it on once the backwash is done and return the unit to AUTO mode. **See 6.7 BACKWASH** for further details.

Check that the plug connections on the Cell and the base of the unit are tight and are in sound condition at least once a year.

### 9.1 Inspecting and Cleaning the Cell Electrode

Reverse Polarity cells should not normally require cleaning, however, in areas with very hard water all calcium may not be removed. A calcium deposit might form on the lower areas of the cell, the sensor, or the sides of the cell plates. This will affect the operation of your chlorinator; however, you can use Cell Cleaner to clean the Cell.

All salt chlorinator cells must be cleaned before scale/calcium builds up to the point where the electrode gaps in the Cell are bridged. If the Cell has an excessive calcium deposit, this may damage the electrode coating, as the bridging causes a rubbing on the place coating, and this will affect the operation.

Check the Cell to prevent the accumulation of pool debris that for any reason may have bypassed the pool filter, particularly after backwashing.

Check that the O-ring is clean, greased with silicone grease (**DO NOT** use petroleum-based jelly) and securely located in the Cell Housing.

#### **For cleaning, please follow these steps:**

Press [POWER/MODE] to OFF as this ensures the pump, and the unit will not turn on.

Unscrew the Cell Locking Ring and remove the electrode for inspection. If calcium build-up is present, immerse the electrode in Cell Cleaner.

A solution can be made by mixing 1-part hydrochloric acid to 10 parts of water. If excessive build up is present a stronger solution may be used to remove the calcium. Using 5 parts of water will make a more aggressive solution but will not damage the Cell. You can use Cell Cleaner and if you do then follow the instructions supplied.

Allow the cleaning solution to dissolve the calcium deposits for about 10 minutes. Dispose of the cleaning solution at an approved Council Depot and never in storm water or sewage drains.

# 9. CHLORINATOR MAINTENANCE

## HANDY TIP:

Returning this mix to your pool only returns the calcium you just removed, so you may be better off reusing the solution until exhausted than disposing of it. Always store this solution in a safe method as advised on the container.

**Do not** scratch or bend the electrode plates in the Cell Housing. Ensure that the O-ring is clean, greased and properly seated.

Rinse the electrode in clean water and re-fit the electrode in the Cell Housing, ensuring that the Cell Locking Ring is hand tight and secure.



When mixing acid with water, **ALWAYS ADD ACID TO WATER. NEVER ADD WATER TO ACID.** Eye Protection, mask and gloves should be worn when cleaning the cell.

## 9.2 Inspecting the Power Pack

Little or no maintenance is normally required with the VAPURE VP-Series Salt Chlorinator Power Pack.

Ensure the Power Pack 3 pin plug plugs into a suitable weatherproof RCD protected 10amp outlet. Ensure that the pump plugs into the 3 pin AC Socket located at the bottom of the Power Pack. Check all plugs and cords for damage. If damaged, then it should be replaced by the manufacturer, their agent or similar qualified person, to avoid a hazard.

If the chlorinator is to be hard wired, then a qualified electrician must complete the installation.

The VAPURE VP-Series Salt Chlorinator Power Pack has air vents to allow internal components to remain cool in hot weather. The VAPURE VP-Series Salt Chlorinator has a special oil spray applied to the inside of the unit during production to stop the insects from entering the unit. To help assist in keeping the insects away, apply a surface spray periodically on the wall or post that the unit is mounted on. DO NOT spray directly into the Power Pack and make sure the power is off when you use a spray. Allow adequate time for the spray to dry before turning the power on again.

# 10. SYSTEM TROUBLESHOOTING



If you suspect for any reason your VAPURE VP-Series Salt Chlorinator is not performing or running as it should be, here are some handy troubleshooting tips that may assist you.

	<b>Fault Indication</b>	<b>Potential Cause</b>	<b>Remedy</b>
10.1	FAULT LED – BLINKS ON-OFF	Numerous causes	See the LCD DISPLAY for the reason then go to that section in this troubleshooting guide
10.2	HIGH SALT WARNING	Salt too high or short on cell plates	Check Salt guide (sec. 6.6/8.2) Check that cell is clear of any foreign materials (e.g., wire, metal, touching plates, etc.)
10.3	INTERNAL TEMPERATURE HIGH	No air flow in the area around the POWER PACK or excessively high salt	Ensure POWER PACK is mounted in a well-ventilated area free of chemicals and fertilisers. Check Salt guide (sec. 6.6/8.2)
10.4	LOW SALT or CLEAN CELL or FAULTY CELL	Low salt level	Check salt level (sec. 6.6/8.2)
		Buildup of calcium on the Cell plates	Calcium acts as an insulator and needs to be removed. See Cleaning of Cell Electrode (sec. 9.1)
		Water temperature is low	Winter water temperature can be very low. For every 1°C below 28°C the output can drop 2-3%
		Insufficient water flow through the Cell	Check water flow and ensure a full chamber of water is passing over the Cell. You may need to backwash your filter (sec. 6.7)
		The Cell could be damaged or at the end of its life	Damaged coating will reduce cell life and reduce output. If all conditions are correct, then Cell could be at the end of its life
		Level low in one direction but OK in the other	Cell may need cleaning (sec. 9.1), or the Cell may have run its life in one direction
10.5	NO CURRENT FLOW - NO OUTPUT	Faulty CONTROL or MAIN PCB	Faulty PCB - contact for service
10.6	WATER FLOW FAULT	Low water flow or no water flow	Possible closed valve, pump fault, burst pipe
		Low water flow	Water does not cover the water sensor
		Low speed pump not supplying sufficient water to cell housing	Increase the speed of the pump until the housing is filled.
10.7	WATER TEMP HIGH	No water flow	Possible closed valve, pump fault, burst pipe
10.8	WATER TEMP LOW	Water temperature is below 10°C	The POWER PACK will lower output when water temperature goes below 10°C to protect the cell plates

# 10. SYSTEM TROUBLESHOOTING

	Fault Indication	Potential Cause	Remedy
10.9	WATER TEMP SUDDEN INCREASE	No water flow	Possible closed valve, pump fault, burst pipe
10.10	Not operating at all - no lights	Not plugged into wall power outlet or power outlet not turned on	Check that POWER PACK POWER CORD goes into wall outlet and outlet is turned on
		Plugged into power outlet and turned on but still no power	Test wall outlet with a working appliance
		Wall power outlet working but still no power	Check CIRCUIT BREAKER at bottom of POWER PACK Press white button to reset if tripped
		Pressed and reset but still no power	If you have checked all the above, then there is an internal fault - contact for service
		CIRCUIT BREAKER stays out in a tripped state	Faulty CIRCUIT BREAKER - contact for service
10.11	Not operating at all - comes on but turns off	CIRCUIT BREAKER resets but trips again	1. Excessively high salt - check salt (sec. 6.6/8.2) and lower it if needed. 2. Short across Cell plates - remove Cell and check the plates for any metal lying across plates. 3. Faulty rectifiers, transformer, or Cell cable, call for service
10.12	Everything displays OK but not turning ON	Incorrect TIMER settings	Press the POWER/MODE button until it is in ON mode. Does it work now?
		Yes, it works now.	Check TIMER settings (sec. 6.52) in CLOCK/TIMER Mode
		No, it does not work.	If the FAULT LED is ON, then refer to 9.1 above. If only LCD DISPLAY is ON, but nothing works - call for service
10.13	Sign of melting or burning of the Cell Connector Plug	Possible moisture entry to the plug	If melted, then it will need replacing otherwise clean with WD40 or similar. Return for service if melted
10.14	OUTPUT reading is less than 100%	Low salt level	Check salt level (sec. 6.6/8.2)
		Buildup of calcium on the Cell plates	Calcium acts as an insulator and needs to be removed. See Cleaning of Cell Electrode (sec. 9.1)
		Water temperature is low	Winter water temperature can be very low. For every 1°C below 28°C the output can drop 2-3%
		Insufficient water flow though the Cell Housing	Check water flow and ensure a full chamber of water is passing over the Cell.  You may need to backwash your filter (sec. 6.7)

# 10. SYSTEM TROUBLESHOOTING

	Fault Indication	Potential Cause	Remedy
		The Cell could be damaged or at the end of its life	Damaged coating will reduce cell life and reduce output. If all conditions are correct, then Cell could be at the end of its life
		Level low in one direction but OK in the other	Cell may need cleaning (sec. 9.1), or the Cell may have run its life in one direction
		Continuous buildup of calcium	See this troubleshooting sec 9.10
10.15	Power Pack only works in one direction. No output in the other direction	Faulty rectifiers, transformer, or PCB	Return unit for service
10.16	Timer is not functioning properly in AUTO	Incorrect settings	Make sure POWER/MODE is set to AUTO. Refer to Timer Setting in this manual (sec. 6.52)
10.17	Pool pump outlet not functioning properly or pump always on	Pump not plugged into the base of chlorinator	Check that the pump is plugged into the bottom of the POWER PACK and not directly into the wall outlet! Make sure you are set in AUTO mode and not MANUAL for normal running
10.18	Cell not cleaning excessive calcium buildup on Cell or Power Pack not changing direction	Excessively high calcium, change of direction time set too high or faulty PCB	1. See Calcium Hardness test (sec 8.5) and adjust water accordingly. 2. Change the Cell Cleaning times (sec. 7.3) 3. Manually try changing direction by holding both [<] and [>] buttons in for 3 sec (you must be in the default display screen for this to work). Failure of this to work could indicate a faulty PCB - return for service
10.19	Low or No Chlorine Output	Unit not working correctly	Go through Troubleshooting from 9.1
		Stabiliser is too low	Check Stabiliser guide (sec 8.6)
		Unit not set correctly	Basic settings such as Output Control and Timer running hours need to be checked. Go through all settings in sec. 5, 6 & 7 and balance water accordingly
		Salt level is too low	Check Salt guide (sec. 6.6/8.2)
		pH is too high	Check pH guide (sec. 8.3)
		Cell at the ends of its life	If full output is not reached, then it could be a failing Cell
10.20	Timer loses time when mains power removed	Battery life expired	In the unlikely event of this occurring, return unit for service

**DISCLAIMER:** Information in this guide is intended to provide general information on a particular subject(s) in good faith and is not an exhaustive treatment of such subject(s). Its use is beyond the control of the author, contributor, publishers, and distributors and should not be relied upon without consulting qualified, professional and comprehensive advice. This guide includes subject(s) that should only be performed by or under the direction and advice of qualified and licensed professionals and under no circumstances should the guide be used as a substitute for such professionals. No representations or warranties are made that the content, advice, and recommendations in this guide are current, free from errors or omissions, or appropriate for the user's circumstances or abilities. No liability or responsibility is accepted for any loss suffered because of any user's reliance on such content. Repairs should only be carried out by qualified persons or Crystal Aquatic Systems appointed agents. Crystal Aquatic Systems reserves the right to refuse a warranty if any damage caused to the chlorinator or auxiliary pool equipment that is not a result of a manufacturer's defect.

# 11. WARRANTY

THIS EQUIPMENT HAS BEEN MANUFACTURED AND TESTED TO THE HIGHEST STANDARD AND ACCORDINGLY CARRIES THE FOLLOWING WARRANTY.

- 11.1 The VAPURE VP-Series Salt Chlorinator Power Pack & Electrolytic Cell will be repaired at no charge, for a period of 4 years or 10 000 hours, whichever occurs first, from the date of purchase should it be found, after examination, that the failure has been caused by faulty workmanship or materials. This is a back to base warranty.
- 11.2 Adverse operating conditions beyond the control of the manufacturer such as improper voltage or water pressure, excessive ambient temperature or any condition that adversely affects the performance of the equipment will render this warranty null and void.
- 11.3 Defective equipment must be returned to the manufacturer or dealer as soon as the purchaser becomes aware of the defect and all transport must be prepaid. Neither the manufacturer nor the dealer shall be responsible for any goods damaged in transit.
- 11.4 If after examination the equipment is found to be defective it will be repaired or replaced free of charge (other than transport costs which will be borne by the purchaser). However, if upon inspection of the equipment it is found that the terms of this warranty are not satisfied, then the usual charges of the manufacturer for repair or replacement will be made.
- 11.5 Any liability of the manufacturer pursuant to the Trade Practices Act 1974, as amended for a breach of a condition or warranty shall be limited to replacing or acquiring the equipment (or part thereof) where the same has been supplied.
- 11.6 The maximum liability incurred by the manufacturer shall not in any case exceed the contract price for the equipment or the product parts or components thereof claimed to be defective. Further, the manufacturer shall not be liable for any loss, damage or delay directly or indirectly caused by any malfunction of or defect of or failure of the equipment other than as expressly provided in this warranty.
- 11.7 Products sold by the manufacturer are designed for use with swimming pool water balanced in accordance with the Langelier Saturation Index with a pH range of 6.8-7.8. The chlorine level should not exceed 4 ppm and the salt level should not exceed 4500 ppm, or 2500 ppm for Freshwater/Ultra-Low Salt Models.
- 11.8 The manufacturer will not be held liable for damage caused by, but not limited to, corrosion, scaling, or stress.

*Our goods come with guarantees that cannot be excluded under the Australian Consumer Law. You are entitled to a replacement or refund for a major failure and compensation for any other reasonably foreseeable loss or damage. You are also entitled to have the goods repaired or replaced if the goods fail to be of acceptable quality and the failure does not amount to a major failure.*



## **The Warranty is void under the following circumstances:**

- Installation is carried out incorrectly, by any person other than a person authorised by us to do so.
- The Power Pack or Cell is serviced by any person other than a person authorised by us to do so.
- Correct salt levels are not always maintained.
- The Power Pack is not protected from the elements.
- The Power Pack is not operated in a position/area with good ventilation.
- Water has been allowed to enter the Power Pack.
- Insect infestation or penetration by dust, sand, or other foreign particles inside the Power Pack.
- Damage beyond our control.
- Equipment that has been misused, neglected, damaged, repaired without authorisation or altered in any way.
- This warranty is applicable to workmanship and materials only.
- This warranty is not transferable under any circumstance.
- Keep your original purchase invoice and serial number in a safe place.



# 11. WARRANTY

Claiming Warranty on your **VAPURE VP-Series Salt Chlorinator**



When making a warranty claim, please note the following information **MUST** be provided or the claim may not be approved.

- Model number
- Power Pack serial number
- Cell serial number
- Proof of purchase showing the purchase date and who purchased from
- Installation date
- Installer
- Your full name
- Your phone number
- Your address details
- The run hours that are displayed in the LCD screen and the alpha/numeric code after it.
- Details of the Issue

**We keep extensive production and sales records so this information will expedite the processing of your claim.**

**Crystal Aquatic Systems reserves the right to modify any model without notice.**

Register your product online:

<http://www.crystalas.com/register/>

Use this handy QR Code to register:



Use this QR code to access online documents:



## 12. TECHNICAL SUPPORT



For all warranty enquiries please contact your local distributor or contact Crystal Aquatic Systems directly and we will either direct you to your nearest authorised repairer or assist you with your enquiry.

**Crystal Aquatic Systems** contact details:

P - 07 5522 9763

E - [service@crystalas.com](mailto:service@crystalas.com)

W - [www.crystalas.com](http://www.crystalas.com)



### DISCLAIMER

Information in this guide is intended to provide general information on a particular subject(s) in good faith and is not an exhaustive treatment of such subject(s). Its use is beyond the control of the author, contributor, publishers, and distributors and should not be relied upon without consulting your local Professional for comprehensive advice.

This guide includes subject(s) that should only be performed by or under the direction and advice of your local Professional and under no circumstances should the guide be used as a substitute for such professionals.

No representations or warranties are made that the content, advice, and recommendations in this guide are current, free from errors or omissions, or appropriate for the user's circumstances or abilities. No liability or responsibility is accepted for any loss suffered because of any user's reliance on such content.



