

MULTIPLUS

**INSTALLATION & USER
GUIDE**

CONTENTS

WIRING INFORMATION	3
MANUAL MODE USER INSTRUCTIONS	4
QUICK SETUP - IRIS	4
QUICK SETUP - ASTRAL CONNECT 10	5
QUICK SETUP - DONTEK AQUATEK	6
QUICK SETUP - PENTAIR	7
QUICK SETUP - JANDY/ZODIAC	8
QUICK SETUP - HAYWARD OMNIDIRECT	8
QUICK SETUP - UNIVERSAL COLORLOGIC	9
MANUAL MULTI PLUS SETUP	10
OPERATING MODE COLOURS	13

READ FIRST

The MULTI-PLUS light has 9 inbuilt modes of operation for use on a variety of different control systems or installation types.

When you first install your MULTI-PLUS light it will operate in the default, **'Manual'** mode for use with a wall switch. see **MANUAL MODE USER INSTRUCTIONS**

When connecting the light to a 3rd party pool controller you will need to change the operating mode of the light, for an expedited setup see **QUICK SETUP** guides for your corresponding pool controller.

If installing MULTI-PLUS lights with legacy Multi Colour and P-Type lights, see **MANUAL MULTI-PLUS SETUP**

PRODUCT SUPPORT & INFORMATION

For further information or technical assistance please feel free to contact our Customer Service Department on:

Phone: +61 3 9793 2299

Email: info@spaelectrics.com.au

Web: www.spaelectrics.com.au

WIRING INFORMATION

MANUAL MODE OPERATION (SYNCHRONISED POOL & SPA)

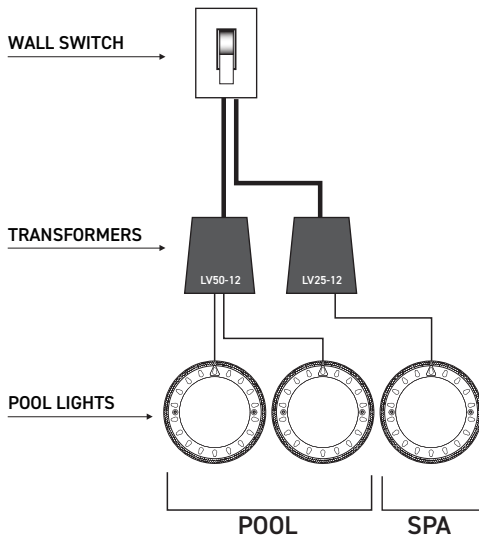

SYNCHRONIZED INSTALLATION

When installing multiple lights, to ensure synchronization and ease of operation ALL Lights must operate from a single switch.

CONNECTING TO POOL/LIGHTING CONTROLLER

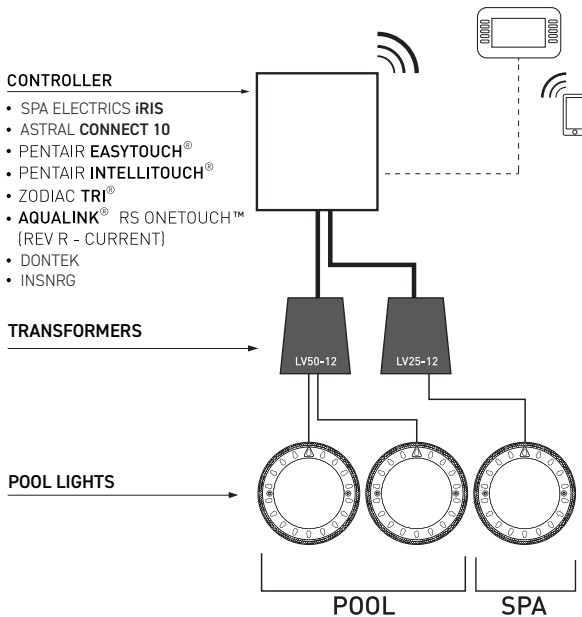

MANUAL MODE USER INSTRUCTIONS

When installing multiple lights, to ensure synchronization and ease of operation ALL Lights must operate from a single switch.

OPERATING INSTRUCTIONS

1. To change the color of the light, simply turn your light **OFF** for **2** seconds and then turn it back **ON**. This will signal the light to proceed to the next colour in sequence.
To select a desired colour, simply step through the colours until you find your desired selection.

Refer to OPERATING MODE COLOURS for available colours.

2. Your lights will automatically save your selected colour once the power has been turned **OFF** for more than **1** minute. So the next time the lights are used, they will illuminate on the last colour operated.
3. To reset or **'synchronize'** your lights; with the power turned **ON**, turn the power **OFF/ON** once rapidly. This will **RESET** your lights to **WHITE**

SYNCHRONIZED INSTALLATION

When installing multiple lights, to ensure synchronization and ease of operation ALL Lights must operate from a single switch.

QUICK SETUP iRIS

The iRIS lighting controller has a QUICK SETUP feature to program the MULTI PLUS lights for iRIS operation.

STEP 1

Ensure the lights have been **OFF** for a minimum of **30 seconds**, then turn the system **ON** using the iRIS handset.

STEP 2

Press the following static colours in order with a **1 second** pause between each press.

1. **WHITE**
2. **RED**
3. **GREEN**

If performed correctly, the lights will illuminate **GREEN**. Confirm correct operation by selecting a different colour using the iRIS handset.

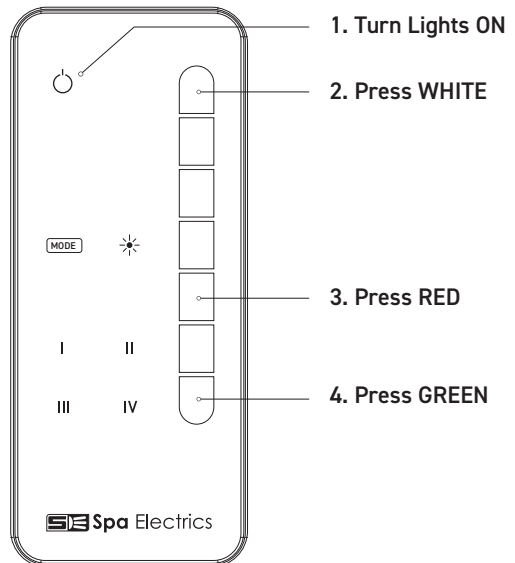

QUICK SETUP ASTRAL CONNECT 10

STAGE 1 - POOL CONTROLLER SETUP

When connecting the Multi Plus light to a Astral Connect 10 pool controller please ensure the system is fully installed and you have completed all the relevant steps in the controller setup menu to operate the lights correctly.

During pool controller setup ensure that the “Zone supports Multi-Colour lighting” checkbox is selected and that the “SLX LIGHT” light model is selected.

**During channel setup select “Yes” when prompted
“Is this a multi-colour capable light?”**

(For more information on this please refer to the pool controller installation manual).

**NOTE: Some older pool controllers may not support these models.
Please contact Spa Electrics assistance.**

STAGE 2 - POOL LIGHT SETUP

Step 1 - Ensure the light has been turned off for at least 30 seconds

Step 2 - Turn the light ON using the Connect 10 Touchscreen

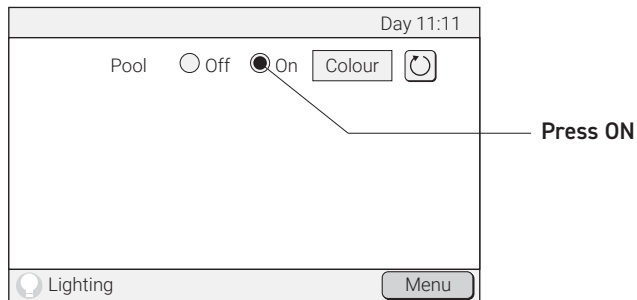

Step 3 - Press the SYNC button,

once the Connect 10 and Multi Plus Light have finished communicating the Multi Plus light can be operated using the Connect 10 pool controller (This step must be performed within 30 second of step 2)

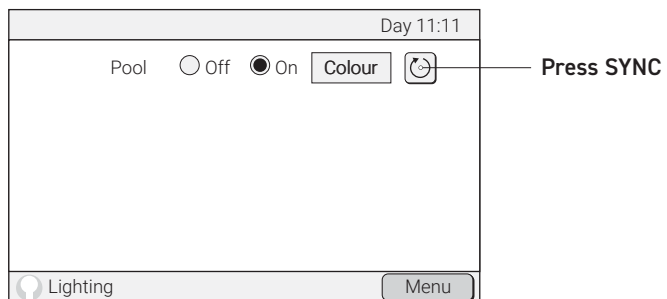

QUICK SETUP DONTEK AQUATEK

STAGE 1 - POOL CONTROLLER SETUP

When connecting the Multi Plus light to a DonteK Aquatek pool controller please ensure the system is fully installed and you have completed all the relevant steps in the controller setup menu to operate the light currently.

Please note the quick setup can only be completed Via the Aquatek not via the unit itself. (For more information on this please refer to the pool controller installation manual).

STAGE 2 - POOL LIGHT SETUP

- Step 1 - Ensure the light is in wall switch mode (default mode out of the box) and has been turned off for at least 30 seconds.
- Step 2 - Select Light Setup from the left right hamburger menu.
- Step 3 - On the socket allocated for the pool/spa light, select Spa Electrics Multi-Plus and press ok.
- Step 4 - Using the colours allocated press White, Red then Green.
- Step 5 - After pressing Green, the Multi Plus light/s will turn themselves off for 1.5 seconds and turn back on Green. This will indicate that the mode has been completed correctly.

DONTEK AQUATEK CONTROLLERS

STEP 2

STEP 3

STEP 4

STEP 4

STEP 4

QUICK SETUP PENTAIR

STAGE 1 - POOL CONTROLLER SETUP

When connecting the Multi Plus light to a Pentair pool controller please ensure the system is fully installed and you have completed all the relevant steps in the controller setup menu to operate the lights correctly.

During pool controller setup ensure that the light model selected is INTELLIBRITE LIGHT

(For more information on this please refer to the pool controller installation manual).

**NOTE: Some older pool controllers may not support these models.
Please contact Spa Electrics assistance.**

STAGE 2 - POOL LIGHT SETUP

Step 1 - Ensure the light has been turned off for at least 30 seconds.

Step 2 - Navigate to the "Lights/Colors" menu on the pool controller Handset or Control Panel.

Step 3 - Select MAGENTA in the colour menu, and wait until the relays finish operating.

Step 4 - Select GREEN in the colour menu, and wait until the relays finish operating.

Step 5 - Select BLUE in the colour menu, and wait until the relays finish operating.

**Step 6 - After 3 seconds the Multi Plus light will turn itself off for 1.5 seconds and turn on BLUE.
This will indicate that the mode setup has been completed correctly**

Note: Steps 3-5 must be performed within 5-90 seconds of the end of the previous Step

INTELLITOUCH/EASY TOUCH CONTROLLERS

F. Circuits ▲ ▶Lights Heat Delay Cancel ▼	Modes ▲ ▶Colors All On All Off ▼	Green ▲ Red White ▶Magenta ▼	▶Green ▲ Red White Magenta ▼	▶Blue ▲ Green Red White ▼			
STEP 2		STEP 3		STEP 4		STEP 5	

AQUALINK TRI CONTROLLERS

Zodiac 00:00 Service Mode Pool Mode Off Pool Heater Off Spa Mode Off Spa Heater Off Settings > Devices > Service Mode >	DEVICES 00:00 Filter Pump Off Spa Off Pool Heat Off Spa Heat Off Lights Off ↓↓More↓↓	INTELLIBRITE LED Red White Magenta Hold Recall ↑↑More↑↑	INTELLIBRITE LED American Mode Cal. Sunset Md Royal Mode Blue Green ↓↓More↓↓	INTELLIBRITE LED American Mode Cal. Sunset Md Royal Mode Blue Green ↓↓More↓↓			
STEP 2		STEP 3		STEP 4		STEP 5	

QUICK SETUP JANDY/ZODIAC

STAGE 1 - POOL CONTROLLER SETUP

When connecting the Multi Plus light to an Aqualink RS/Z4 pool controller please ensure the system is fully installed and you have completed all the relevant steps in the controller setup menu to operate the lights correctly.

**During pool controller setup ensure that the light model selected is
JANDY LED LIGHT**

(For more information on this please refer to the pool controller installation manual).

NOTE: Some older pool controllers may not support these models. Please contact the controller manufacturer for upgrade assistance.

STAGE 2 - POOL LIGHT SETUP

Step 1 - Ensure the light has been turned off for at least 30 seconds.

Step 2 - From the home screen on the control panel, Select "Equipment ON/OFF".

Step 3 - Select the channel for the lights, each channel will need to be setup individually.

Step 4 - Select DISCO TECH in the "Set Color" menu.

Step 5 - After the controller finishes power cycling, the Multi Plus light will turn itself off for 1.5 seconds and turn on DISCO TECH. This will indicate that the mode setup has been completed correctly

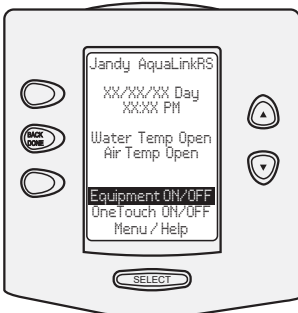

Step 2

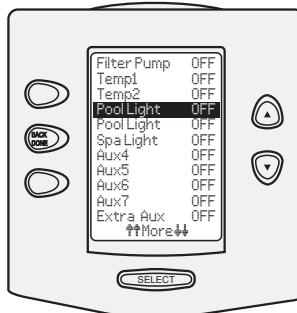

Step 3



Step 4

QUICK SETUP Hayward OmniDirect

STEP 1

Completely TURN OFF the power to the Hayward OmniLogic/OmniDirect Controller and wait for at least 20 seconds.

STEP 2

TURN ON the controller and wait until the lights turns ON.

Lights will initially run for 15 seconds on WHITE Color.

After 15 seconds of WHITE Color, the Hayward controller will automatically perform 3 quick power cycles.

Once the 3 quick power cycles are complete, the Spa Electrics MultiPLUS lights will Turn OFF for 1.5 seconds and turn on ORANGE color indicating setup is complete and lights are now in OmniDirect mode.

NOTE: After the above steps are complete, lights will run for 15 seconds then the controller will TURN OFF the lights automatically.

QUICK SETUP UNIVERSAL COLORLOGIC

STAGE 1 - POOL CONTROLLER SETUP

When connecting the Multi Plus light to an Omnilogic pool controller please ensure the system is fully installed and you have completed all the relevant steps in the controller setup menu to operate the lights correctly.

During pool controller setup ensure that the light model selected is
(UCL) UNIVERSAL COLORLOGIC

NOTE : When prompted “Do you have any Universal ColorLogic lights that you’d like to set to UCL operational mode?” - Select **NO**

(For more information on this please refer to the pool controller installation manual).

NOTE: Some older pool controllers may not support these models. Please contact the controller manufacturer for upgrade assistance.

STAGE 2 - POOL LIGHT SETUP

Step 1 - Ensure the light has been turned off for atleast 30 seconds.

Step 2 - Navigate to the “Colour Shows” menu on the Omnilogic Control Panel.

Step 3 - Slide the power slider to ON and wait until the “Light is Busy” message ends.

Step 4 - Press the RESET button and wait until the “Light is Busy” message ends.

Step 5 - Select COOL CABARET in the Colour Shows menu
and wait until the “Light is Busy” message ends.

Step 6 - After 3 seconds the Multi Plus light will turn itself off for 1.5 seconds and turn on COOL CABARET. This will indicate that the mode setup has been completed correctly

Note: Steps 4-5 must be performed within 5-90 seconds of the end of previous Step

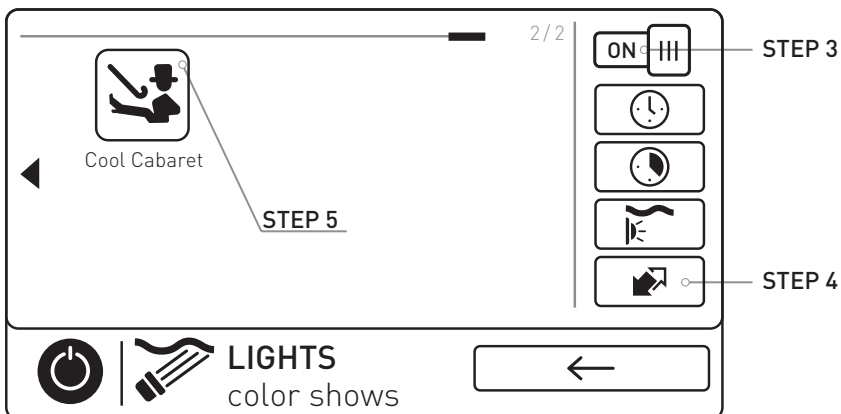

MANUAL MULTI PLUS SETUP

Manual Multi Plus Setup is for installations where the use of a quick setup is not possible or a new MULTI-PLUS light is being installed with an existing Multi Colour or P-Type light.

The MULTI-PLUS light has 9 inbuilt modes of operation for use on a variety of different control systems or installation types.

When you first install your MULTI-PLUS light it will operate in the default, 'Manual' mode for use with a wall switch. In order to connect the light to a 3rd party pool controller OR change to a different operating mode please follow the below steps.

STEP 1 - POOL CONTROLLER SETUP

If connecting to a pool controller, please ensure the system is fully installed and you have completed all the relevant steps in the controller setup menu to operate the lights correctly.

During pool controller setup you will be prompted to select which light model is installed. Please use the below table to select the appropriate light for your pool controller type.

(For more information on this please refer to the pool controller installation manual).

POOL CONTROLLER	SELECT LIGHT MODEL	POOL CONTROLLER	SELECT LIGHT MODEL
Astral Connect 10 (2016 to current)	SLX Light	Hayward Omnilogic	(UCL) Universal Colorlogic
Astral Connect Lite/+	SLX Light	Pentair EasyTouch	Intellibrite
Astral Halo Lite 2 and 4	SLX Light	Pentair IntelliTouch	Intellibrite
Jandy Aqualink RS (F/W Rev. 'R'-Current)	Jandy	Dontek	Spa Electrics MULTI-PLUS
Zodiac Aqualink TRI/Z4	Jandy	INSNRG	Spa-E MULTI PL

NOTE: Some older pool controllers may not support these models. Please contact the controller manufacturer for upgrade assistance.

STEP 2 - LIGHT SETUP

IMPORTANT: Ensure Lights have been off for at least **30 seconds** prior to performing this step.

NOTE: This step can either be performed via a wall switch OR via the controller panel/Mobile App.

A. TURN LIGHTS **ON** → WAIT 1 SECOND → TURN LIGHTS **OFF** → WAIT 12 SECONDS (min 10s - max 15s) → [REPEAT x 3]

B. TURN LIGHTS **ON** → [ALL LIGHTS NOW FLASHING RED]

NOTE: If ALL Lights connected to circuit are NOT continuously flashing RED, please turn Lights **OFF** & wait 30 seconds before repeating STEP 2

Continue to STEP 3

MANUAL MULTI PLUS SETUP cont.

STEP 3 - SELECTING OPERATING MODE

After accessing SETUP MODE (STEP 2) the lights will **FLASH RED** continuously. This is MODE 1 (Manual mode)

Use the below process to change the operating mode to correspond to the required controller or operating type below.

TURN LIGHTS **OFF**

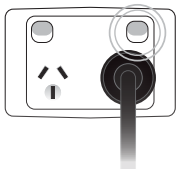

WAIT **1** SECOND

TURN LIGHTS **ON**

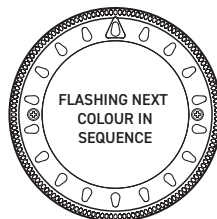
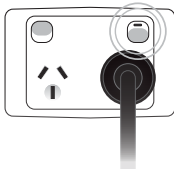

IMPORTANT: Once desired mode is reached (i.e. "Flashing Green - iRIS Mode) leave power turned ON and continue to STEP 4

'FLASHING' COLOUR	CONTROLLER / OPERATING TYPE	LIGHT MODEL SELECTED*
1. RED	Manual Mode (wall switch)	-
2. GREEN	Spa Electrics iRIS Controller	-
	Dontek Aquatek	-
3. MAGENTA	Astral Connect 10 (2016 to current)	SLX Light
4. WHITE	Jandy Aqualink RS (F/W Rev. 'R'-Current)	Intellibrite Light
	Zodiac Aqualink TRI	Intellibrite Light
	Pentair EasyTouch/ IntelliTouch/ IntelliCentre	Intellibrite Light
5. BLUE	RGB MULTI Mode* (wall switch)	-
	Dontek Aquatek	-
6. YELLOW	Hayward Omnilogic	Universal Colorlogic
7. PINK	P-TYPE Mode* (Legacy)	Intellibrite Light
8. AQUA	Aqualink RS/Z4	Jandy
9. ORANGE	Hayward OmniLogic	OmniDirect
10. LIME	-	-

Continue to STEP 4



*Light Model Selected:

This indicates the model of light to be selected in the Pool Controller setup menu.

Refer to STEP 1 on the previous page, for more information or please contact Spa Electrics. (03) 9793 2299

*RGB MULTI Mode:

This mode allows the MULTI PLUS light to operate in the standard MULTI-Colour mode. This mode should only be used when operating a MULTI PLUS light from a wall switch with a standard Spa Electrics MULTI-Colour light. For more information please contact Spa Electrics.

*P-TYPE Mode:

This mode allows the MULTI PLUS light to operate in the RGB P-Type Colour mode. This mode should only be used when operating a MULTI PLUS light in conjunction with an existing Spa Electrics P-Type light. For more information please contact Spa Electrics.

MANUAL MULTI PLUS SETUP cont.

STEP 4 - SAVING OPERATING MODE

Once the desired operating mode is selected follow these steps to save the selection.

TURN SYSTEM **OFF**

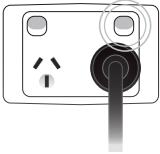

WAIT **30** SECONDS

TURN SYSTEM **ON**

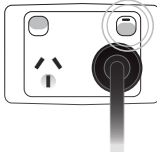

Important

You must wait at least **30** Seconds prior to turning the system back **ON** or selection process will fail and setup will need to be restarted.

STEP 5 - CONFIRM OPERATION

Your setup should now be complete. To confirm the system is working correctly, select a colour via the controller or wall switch (depending on operating mode selected) and check to ensure all lights are synchronised and the correct colour is displayed.

Refer to OPERATING MODE COLOURS for available colours.

OPERATING MODE COLOURS

MANUAL MODE	
1	WHITE 4000K
2	AQUA
3	BLUE
4	MAGENTA
5	RED
6	LIME
7	GREEN
8	OCEANIC VIEWS
9	TRANSCENDENCE
10	OUTBACK AUSTRALIA
11	SPRING EQUINOX

STANDARD MULTI* MODE	
1	BLUE
2	MAGENTA
3	RED
4	LIME
5	GREEN
6	AQUA
7	WHITE 1
8	WHITE 2
9	SLOW COLOUR BLEND
10	FAST COLOUR CHANGE

***Standard MULTI Mode:**

This mode allows the MULTI PLUS light to operate in the standard MULTI-Colour mode. This mode should only be used when operating a MULTI PLUS light from a wall switch or RM-2, in conjunction with a standard Spa Electrics MULTI-Colour light.

For more information please contact Spa Electrics. (03) 9793 2299



© COPYRIGHT 2024 SPA ELECTRICS PTY. LTD.

ALL RIGHTS RESERVED

Connect 10® is a registered trademark of AstralPool Australia and/or its affiliated companies in the United states or other countries.
IntelliBrite® is a registered trademark of Pentair Water Pool and Spa, Inc and/or its affiliated companies in the United states or other countries.
Colorlogic® is a registered trademark of Hayward Industries Inc. and/or its affiliated companies in the United states or other countries.
Aqualink® is a registered trademark of Zodiac group Australia and/or its affiliated companies in the United states or other countries.
Spa Electrics Pty Ltd and it's brands are not affiliated or endorsed by these companies and/or their brands.